

# Contents

---

<b>CONTENTS</b>	<b>1</b>
<b>CHAPTER 1 NOTES ON SAFETY, USAGE, MAINTENANCE AND SERVICE</b>	<b>5</b>
1.1 Safety notes	5
1.2 Usage Notes	6
1.3 Maintenance	6
1.4 Cleaning	6
1.5 Calibration	6
1.6 Service	6
1.7 Replacing Components	6
1.8 Power-saving mode	6
<b>CHAPTER 2 TECHNICAL DATA</b>	<b>7</b>
<b>CHAPTER 3 CONTROL AND CONNECTION ELEMENTS, PIN CONFIGURATIONS</b>	<b>13</b>
3.1 Front panel	13
3.2 Left side view	13
3.3 Right side view	14
3.4 Rear panel	14
3.5 Scart socket (EU AV)	14
3.6 RS 232	15
3.7 TS parallel	15
3.8 12V power supply	15
3.9 Headphone jack	15
3.10 DVI Output	15
<b>CHAPTER 4 STARTUP</b>	<b>16</b>
4.1 Mains operation	16
4.2 Battery operation	16
4.2.1 NiMH battery operation (battery charge display using battery symbol)	16
4.2.1.1 Changing the NiMH battery (Type HHR450AB F10)	16
4.2.1.2 Charging the NiMH battery	16
4.2.1.3 Discharge warning (NiMH battery)	17
4.2.2 Lithium-Ion battery operation (Option) (battery charge display using battery symbol)	18
4.2.2.1 Changing the Lithium-Ion battery (Type Pana CGR 18650)	18
4.2.2.3 Lead battery operation (battery charge display using percentage)	18
4.2.2.3.1 Inserting the lead battery	18
4.2.2.3.2 Recharging the lead battery (delivery later January 2003)	18
4.2.2.3.3 Discharge warning (lead battery)	19
4.3 External 12V power supply	20
<b>CHAPTER 5 ANALOG LEVEL MEASUREMENT AND VIDEO CHECK</b>	<b>21</b>
5.1 Selecting the range	21
5.2 Remote supply (from software version xx.10)	
(5 V remote supply for unit deliveries startign from August 2004)	21
5.2.1 Setting the remote supply	22
5.3 FM broadcasting range (with RDS - delivery later June 2003)	22
5.4 Television ranges (terrestrial and broadband cable ranges)	23
5.4.1 Setting the colour standard (PAL, SECAM, NTSC)	24
5.4.2 Sound carrier level measurement, SC2 listen	
(optional stereo and dual sound indicator)	24
5.5 Satellite range	25
5.5.1 Frequency input (1. SAT-IF or direct RF transponder frequency)	25
5.5.2 Video deviation	28
5.5.3 Setting the colour standard (PAL, SECAM, NTSC)	29
5.6 LNB supply	29

5.7	Output of signal frequency (22kHz)	30
5.7.1	DiSEqC control (version 1.0, version 1.2 and version 2.0)	30
5.7.1.1	Additional settings for DiSEqC 1.2	32
5.7.1.2	Additional settings for DiSEqC 2.0	32
5.7.2	UNICABLE System	34
5.8	Sound carrier selection	37
5.9	Relative measurement (C/N measurement)	37
5.10	S/N measurement, C/N measurement (optional)	38
5.11	Television return channel range	38
5.12	Television IF range	38
5.13	Frequency detuning	39
5.14	Station search	39
5.15	Blanking interval	40
5.16	SCOPE (optional)	40
5.16.1	Introduction	40
5.16.2	Selecting the SCOPE function	41
5.16.3	Selecting a line	41
5.16.4	Freezing the oscillogram	42
5.16.5	Zoom function	42
5.16.6	Hum measurement	42
5.16.7	Selecting the S/N line	42
<b>CHAPTER 6</b>	<b>TELETEXT</b>	<b>43</b>
<b>CHAPTER 7</b>	<b>MEASUREMENTS IN THE DIGITAL RANGE</b>	<b>44</b>
7.1	Selecting the range	44
7.2	Remote supply	44
7.3	DVB-S (QPSK)	44
7.3.1	Changing the symbol rate	45
7.3.2	Level measurement	45
7.3.3	Searching, frequency detuning	45
7.3.4	Assessing the picture and sound	45
7.3.5	Measuring the bit error rate (CBER or VBER)	45
7.3.6	Measuring the carrier frequency offset	46
7.3.7	Measuring the IQ phase position	46
7.3.8	Measuring the signal to noise ratio (S/N) in the baseband	46
7.3.9	Constellation diagram (QPSK)	47
7.4	DVB-S2 (QPSK, 8PSK), DVB-S1 (QPSK) (with optional DVB-S2 card only)	47
7.4.1	Changing the symbol rate	47
7.4.2	Level measurement	48
7.4.3	Searching, frequency detuning	48
7.4.4	Assessing the picture and sound	48
7.4.5	Testing the bit error ratio for DVB-S1 (CBER or VBER)	49
7.4.6	Testing the bit error rate for DVB-S2 (CBER or PER)	49
7.4.7	Measuring the carrier frequency offset	50
7.4.8	Measuring the IQ phase position	50
7.4.9	Measuring the signal to noise ratio (S/N) in the baseband	50
7.4.10	Constellation diagram (QPSK,8PSK)	50
7.5	DVB-C (QAM) or DOCSIS	50
7.5.1	Changing the symbol rate and modulation	51
7.5.2	Level measurement	51
7.5.3	Searching, frequency detuning	51
7.5.4	Assessing the picture and sound	52
7.5.5	Measuring the bit error rate (BER)	52
7.5.6	Measuring the carrier frequency offset	52
7.5.7	Measuring the IQ phase position	53
7.5.8	Measuring the modulation error rate (MER)	53
7.5.9	Measuring the package error rate (PER) (only for devices with 256QAM and tuner TD1316)	53
7.5.10	DOCSIS	54
7.5.11	Constellation diagram (QAM)	54
7.6	DVB-T (COFDM) optional	54
7.6.1	Level measurement	55

7.6.2	Searching, frequency detuning-----	55
7.6.3	Assessing the picture and sound -----	56
7.6.4	Measuring the bit error rate (CBER (from October 2002) or VBER)-----	56
7.6.5	Measuring the IQ phase position -----	57
7.6.6	Measurement of signal-noise distance (S/N) or rather the modulation error rate (MER) in the base band-----	57
7.6.7	Impulse response-----	57
7.6.8	Constellation diagram (COFDM)-----	58
7.7	Constellation diagram -----	58
7.7.1	Accessing the constellation diagram-----	59
7.7.2	Freezing the diagram -----	59
7.7.3	Zoom function -----	59
7.7.4	Measuring phase jitter with QAM (only for devices with 256QAM and tuner 1316)-----	59
7.7.5	Hum measurement at QAM-----	60
7.7.6	Single carrier representation with COFDM-----	60
7.8	Examples of constellation diagrams with various errors and their causes -----	62
<b>CHAPTER 8</b>	<b>MPEG DECODER (OPTIONAL) -----</b>	<b>65</b>
8.1	Introduction-----	65
8.1.1	DVB and MPEG-2 -----	65
8.1.2	HDTV and MPEG-4 -----	66
8.2	Operation (MPEG-2 and MPEG-4 decoder) -----	66
8.3	MPEG transport stream interface-----	68
8.4	Displaying the MPEG video parameters -----	68
8.5	Measurement and display of the video bit rate-----	68
8.6	DVI Interface (Option in connection with MPEG-4 decoder)-----	68
8.7	NIT evaluation -----	68
8.8	Printing out the NIT (Network Information Table)-----	70
8.9	CI (Common Interface) to EN50221 -----	70
<b>CHAPTER 9</b>	<b>TUNING MEMORY -----</b>	<b>73</b>
9.1	Saving -----	73
9.2	Memory locations -----	73
9.3	Accessing memory -----	73
9.4	Sequence of memory positions -----	73
9.5	Erasing a memory location -----	73
<b>CHAPTER 10</b>	<b>ANALYZER-----</b>	<b>74</b>
10.1	Starting analyzer -----	75
10.1.1	Start the analyser in the SAT range when UNICABLE is activated. -----	76
10.2	FM range-----	76
10.3	Return channel range-----	76
10.4	IF range -----	77
10.5	TV range -----	77
10.5.1	VHF, VHF-S, UHF -----	77
10.5.2	Cable range -----	77
10.5.3	TV – Complete -----	77
10.6	SAT range -----	78
10.7	Finding a frequency with the cursor-----	78
<b>CHAPTER 11</b>	<b>LIST OF SPECIAL PROGRAMS -----</b>	<b>79</b>
<b>CHAPTER 12</b>	<b>SPECIAL PROGRAMS-----</b>	<b>80</b>
12.1	Erasing tuning memory-----	80
12.2	Turning LCD backlighting on and off-----	80
12.3	Changing the standard -----	81
12.4	Changing the language -----	81
12.5	Automatic printout -----	81
12.6	Automatic storage -----	82
12.7	Displaying data and time-----	84
12.8	Setting data and time -----	84
12.9	Editing protocol header-----	84
12.10	Printing protocol header-----	85

12.11	Deactivation of the high pass filter for channel S2/S3-----	85
12.12	Deactivating/activating power-saving mode-----	85
12.13	Switching the detuning resolution (SAT)-----	86
12.14	Switching the detuning input (SAT)-----	86
12.15	Activating/deactivating the hum measurement during printing-----	86
12.16	Selection of sound carrier measurement (absolute oder relative)-----	87
12.17	Selection of signal bandwidths with COFDM-----	87
12.18	Switching the measuring resolution-----	88
12.19	Switching the dB display size-----	88
12.20	Setting the analog bar display-----	88
12.21	Relative measurement (with C/N display capability in SAT range)-----	88
12.22	S/N measurement → line switch (optional)-----	89
12.23	Serial number and release code for documentation software-----	89
12.24	Battery charge display-----	90
12.24.1	NiMH battery operation-----	90
12.24.2	Lead battery operation-----	90
12.25	Displaying software version-----	91
12.26	Protect memory area-----	91
12.27	Default setting-----	92
12.28	RS-232 interface-----	92
12.29	Monitoring program-----	93
12.30	Measured value storage-----	96
12.31	LNB current measurement-----	98
<b>CHAPTER 13</b>	<b>PRINTER FUNCTIONS-----</b>	<b>99</b>
13.1	Paper refill-----	100
13.1.1	Manual paper feed-----	101
13.1.2	Automatic paper feed-----	101
13.2	Cleaning the heating bar (only when necessary)-----	102
<b>CHAPTER 14</b>	<b>MONITOR FUNCTION, SCART PARAMETERS-----</b>	<b>103</b>
<b>CHAPTER 15</b>	<b>NICAM DECODER / ADR DECODER (OPTIONAL)-----</b>	<b>105</b>
15.1	NICAM decoder-----	105
15.2	ADR decoder-----	107
<b>CHAPTER 16</b>	<b>DEFINITION OF LEVEL-----</b>	<b>109</b>
<b>CHAPTER 17</b>	<b>LIST OF TV CHANNELS-----</b>	<b>110</b>
17.1	B/G standard-----	110
17.2	B/G standard (Australien)-----	111
17.3	D/K standard (OIRT)-----	112
17.4	D/K standard (China PAL)-----	113
17.5	M/N standard-----	114
17.6	L standard-----	115
17.7	I standard-----	116
<b>CHAPTER 18</b>	<b>DISEQC COMMAND TABLE-----</b>	<b>117</b>
18.1	Start byte-----	117
18.2	Address byte-----	117
18.3	Command byte-----	118
18.4	Optional data byte-----	118
18.5	Configuration data-----	118
18.5.1	Switching state byte-----	118
18.5.2	Status byte-----	119
18.5.3	Configuration byte-----	119
<b>INDEX</b>	<b>-----</b>	<b>120</b>

## Chapter 1

# Notes on Safety, Usage, Maintenance and Service

---

### 1.1 Safety notes

This instrument is built and tested according to DIN 57 411 Part 1/VDE 0411 Part 1 (protective measures for electronic measuring instruments). The instrument is in perfect working order upon leaving the factory. To ensure safe and proper operation, the user must observe all the notes and warnings contained in this instruction manual.

The operational safety of the instrument must be checked at regular intervals. For more information, refer to government safety regulations regarding the inspection of non-stationary equipment. During inspection, make sure the carrying handle is functioning properly as well.

If a problem is detected with the measuring receiver, this means that it does not or no longer corresponds to electro-technical regulations, make sure that the problem is immediately remedied.

Repairs are only to be carried out by qualified personnel.

The instrument complies with the IP20 protection class specified by IEC 529 and EN 60529. It is not splash-proof.

Do not use the instrument if it has been exposed to moisture.

Before turning on the instrument, make sure the applied supply voltage matches the specified operating voltages (see Technical Data). Observe the relevant regulations if the supply voltage is changed. Check the electrical strength of the instrument.

Voltage-carrying parts may become exposed if the enclosure is opened (unless it can be opened manually like the printer cover). All voltage sources must therefore be disconnected from the instrument before opening it. Capacitors may still be charged even if disconnected from all voltage sources.



Connection points (eg, RF input) may be energized.

Only use fuses of the specified type and current rating. Never bridge a fuse.

Safety components (-sign) may only be replaced with original parts when carrying out repair work.

Lithium batteries must not be exposed to high temperatures or fire. If battery is replaced incorrectly, there is a risk of explosion. Replace the batteries only with the original type (available from a salesman in your area, wholesaler, or the manufacturer of the instrument). Do not short-circuit the batteries. Lithium batteries are hazardous waste. Only dispose of them in containers provided for this purpose.

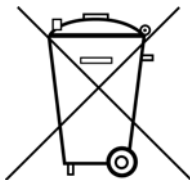

#### Passage from the battery regulations (BattV)

This device contains a battery which incorporates hazardous substances. It must not be disposed of as domestic waste. At the end of its working life it should be disposed of only through the ESC customer service department or at a designated collection point.

## 1.2 **Usage Notes**



Make sure external voltages higher than  $70V_{\text{eff}}$  ( $60V_{\text{eff}}$  = Instrument delivered before April 2010) do not act on the RF input. Higher voltages can destroy the input circuits.

Mechanical effects may seriously damage the LCD display or TFT screen. Defects resulting from extraneous causes render the warranty null and void.

To ensure accurate measurements, turn on the instrument and allow it to warm up for 10 minutes.

The contrast of the LCD deteriorates at temperatures below  $5^{\circ}\text{C}$ .

Please note that LCD's function best after a 10-minute warm-up period.

The use of mobile phones close to the instrument can cause disturbances of the meter.

The use of adapters at the input socket can cause failures in the measurement up to 3 dB.

## 1.3 **Maintenance**

The instrument is maintenance-free.

## 1.4 **Cleaning**

The enclosure should be cleaned with soft, lint-free cloth. To remove heavy dirt build-up without damaging the surface, use a mild detergent, a solvent-free cleaner or a spirit-based cleaner.

Use soft, lint-free cloth or a soft brush to clean the keypad. Compressed air (max. 2 bar) may also be used to remove dirt build-up. Avoid the use of solvents.

Remove all the dust from the inside of the instrument at regular intervals to ensure proper ventilation of individual components. Remove dust deposits with a brush or compressed air (max. 2 bar). Do not use solvents.

## 1.5 **Calibration**

The instrument should be calibrated every one to two years. It is automatically calibrated at the factory if returned to the manufacturer for upgrading, servicing or repairs.

## 1.6 **Service**

Service address: see back cover of operating manual.

## 1.7 **Replacing Components**

Contact customer service before trying to service the instrument by yourself. Any work that requires disassembly should be performed by qualified personnel only. Note that the instrument will have to be recalibrated after replacing or repairing any frequency-related components.

## 1.8 **Power-saving mode**

The optional MPEG-4 decoder also adds a power-saving mode.

For more detailed information, refer to the section "**Deactivating/activating power-saving mode**" in the chapter "**Special Programs**".

## Chapter 2

## Technical Data

		Subject to change	
<b>Frequency ranges:</b>			
<b>IF measurement</b> (via integrated converter)		5 - 47 MHz in 50kHz increments	
<b>Return channel</b> (via integrated converter)		5 - 65 MHz in 50kHz increments	
<b>FM broadcasting:</b> integrated VHF tuner		87.5 - 108 MHz in 10kHz increments	
<b>Television:</b>	analog	<b>frequency input</b> (video carrier frequency) 44.75 - 867.25MHz in 50kHz increments	
		<b>channel input</b> all channels and special channels of all standards (B/G, D/K, L, I, M/N,D/K (CHINA), B/G (Australia))	
<b>Television:</b>	digital – QAM	<b>frequency input</b> (channel centre frequency) 47 - 870MHz in 50kHz increments	
		<b>channel input</b> all channels and special channels of all standards (B/G, D/K, L, I, M/N,D/K (CHINA), B/G (Australia))	
<b>SAT</b>	analog	910 - 2150MHz in 1MHz or 125kHz increments	
<b>SAT</b>	digital – QPSK	910 - 2150MHz in 1MHz or 125kHz increments	
<b>Frequency/channel input</b>		via keypad	
<b>User prompting</b>		via backlit graphical LCD	
<b>RF/IF input</b>		IEC socket / 75Ω (DIN 45 325) return loss > 10 dB (910 - 2150MHz) return loss > 12 dB (5 - 867.25MHz)	
<b>Input attenuator</b>		0 - 60 dB in 2 dB increments (processor-controlled)	
<b>Measuring range</b>		<i>Instrument delivered before April 2006</i>	
IF	(5 - 47MHz)	25 - 120dBμV	30 - 126dBμV
Return channel	(5 - 65MHz)	25 - 120dBμV	30 - 126dBμV
FM broadcasting	(87.5 - 108MHz)	20 - 120dBμV	20 - 126dBμV
Television, analog	(44.75 - 867.25MHz)	20 - 120dBμV	20 - 126dBμV
Television, digital	(47 - 870MHz)	20 - 120dBμV	24 - 126dBμV
SAT, analog	(910 - 2150MHz)	30 - 120dBμV	40 - 126dBμV
SAT, digital	(910 - 2150MHz)	30 - 120dBμV	40 - 126dBμV
<b>Measuring bandwidth</b>	<b>IF</b>	200MHz (peak detector)	
	<b>Return channel</b>	200MHz (peak detector)	
	<b>FM broadcasting</b>	200kHz (mean detector)	
	<b>Sound carrier</b>		
	<b>analog (SC1/SC2)</b>	200kHz (peak detector)	
	<b>NICAM</b>	200kHz (peak detector)	
	<b>Video carrier</b>	1MHz (peak detector)	
	<b>QAM</b>	4 MHz (peak detector) at symbol rate ≥ 5000kBd 1 MHz (peak detector) at symbol rate < 5000kBd 200 kHz (peak detector) at symbol rate < 2500kBd calculated bandwidth correction	
	<b>COFDM</b>	4 MHz (peak detector) calculated bandwidth correction	
	<b>SAT analog</b>	8MHz (peak detector)	
	<b>QPSK</b>	8 MHz (peak detector) at symbol rate ≥ 7000kBd 4.3 MHz (peak detector) at symbol rate < 7000kBd 1 MHz (peak detector) at symbol rate < 4500kBd calculated bandwidth correction	

<b>Measuring bandwidth Analyzer</b>		
Return channel, RF	total	gesamt 200kHz (peak detector) 70kHz (peak detector)
Broadcasting		200kHz (mean detector)
Television	total	1MHz (peak detector)
	narrow	70MHz (peak detector)
SAT	total	8MHz (mean detector)
	narrow	4.3MHz (mean detector)
<b>Level indicator</b>		in dBµV (zoomable to 2x level) and audio or via trend bar graph
<b>Level resolution</b>		1dB or 0.1dB
<b>Measuring accuracy</b>		± 1.5dB (at 20°C) ± 2.0dB (0°C-40°C) after a warm-up period of approx. 10 minutes
<b>Colour standards</b>		PAL, NTSC, SECAM
<b>Television standards</b>		B/G, D/K, L, I, M/N, D/K (CHINA), B/G (Australia)
<b>Video features (analog)</b>		
Teletext		DIN 45060
Vertical blanking interval		can be switched on/off
Video bandwidth		5MHz
De-emphasis (SAT)		per CCIR 405-1
Video deviation matching (SAT)		for 16MHz/V or 25MHz/V
Video inversion (SAT)		for C-band reception
<b>Audio features (analog)</b>		
FM broadcasting		stereo indicator, radio data system (rds)
Television		all audio standards; for technical reasons, sounds in the L-band cannot be made audible for the L standard Optional: stereo indicator and dual sound indicator
SAT audio subcarrier		5.00 - 9.75MHz in 10kHz increments
<b>Constellation diagram</b>		
Repetition rate		IQ analysis of digitally modulated signals real time
3D display (status frequency)		in colour
Zoom function		in all quadrants
Stop function		freezes the diagram
<b>QAM demodulator</b>		(per ETS 300429)
Modulation scheme		16, 32, 64, 128 and 256 QAM
Roll-off factor		0.15
Symbol rates		5000 - 7200kBd (5.0 - 7.2Msym/s) 500 – 7200kBd (delivery later November 2003)
Equalizer		self-adapting
Reed-Solomon decoder		204, 188, 8
Interleaving		convolutional interleaver (Forney)
Descrambling		
<b>QAM measuring parameters</b>		(per ETR 290)
Bit error rate		10 <sup>-2</sup> to 10 <sup>-8</sup> (before Reed-Solomon)
Modulation error ratio (MER)		10 - 38dB 0.1dB or 1.0dB resolution
I/Q analysis		via constellation diagram
DOCSIS function		DOCSIS 64 QAM and DOCSIS 256 QAM



<p><b>QPSK demodulator (DVB-S1)</b>                  Roll-off factor                  Symbol rates                    Code rates                  Reed-Solomon decoder                  Interleaving                  Descrambling</p>	<p>(per ETS 300421)                  0.35                  2000 to 30000kBd (2 to 30Msym/s)                  2000 to 45000 kBd (delivery later April 2004)                  1/2, 2/3, 3/4, 5/6, 6/7, 7/8 auto search                  204, 188, 8                  convolutional interleaver (Forney)</p>
<p><b>QPSK measuring parameters (DVB-S1)</b>                  Bit error rate                  VBER                    CBER                  Signal-to-noise ratio (S/N)                  I/Q analysis</p>	<p>(per ETR 290)                  10<sup>-2</sup> to 10<sup>-8</sup>                  10<sup>-2</sup> to 10<sup>-8</sup>                  (bit error rate after Viterbi or before Reed-Solomon)                  10<sup>-2</sup> to 10<sup>-8</sup> (bit error rate before Viterbi)                  2 to 15 dB or 2 to 18 dB, 0.1dB resolution                  via constellation diagram</p>
<p><b>DVB-S2 demodulator (optional)</b>                  Roll-off factor                  Symbol rates                  Code rates                  LDPC and BCH decoder</p>	<p>0.20, 0.25, 0.35                  10000 - 30000kBd (10 to 30Msym/s)                  1/2, 3/5, 2/3, 3/4, 4/5, 5/6, 8/9, 9/10 auto search</p>
<p><b>DVB-S2 measuring parameters (optional)</b>                  Bit error rate                  PER                    CBER                  Signal-to-noise ratio (S/N)                  I/Q analysis</p>	<p>10<sup>-2</sup> to 10<sup>-5</sup> (packet error)                    10<sup>-2</sup> to 10<sup>-8</sup> (bit error rate before correction)                  2 to 18dB, 0.1dB resolution                  via constellation diagram</p>
<p><b>MPEG-2 decoder (Alternative option to MPEG-4 decoder)</b>                    Video decoding                  MPEG-2 MP@ML                  Audio decoding                  MPEG-2 Layer I/II</p>	<p>ISO/IEC 13818-2                    ISO/IEC 13818-3</p>
<p><b>MPEG-4 decoder (Alternative option to MPEG-2 decoder)</b>                    Video decoding                  MPEG-2 MP@ML                  MPEG-4 AVC                  Audio decoding                  MPEG-2 Layer I/II                  MPEG-2 AAC                  MPEG-4 AAC                  Dolby Digital AC-3</p>	<p>ISO/IEC 13818-2                  ISO/IEC 14496-10                  ITU-T H.264                    ISO/IEC 13818-3                  ISO/IEC 13818-7                  ISO/IEC 14496-3</p>
<p><b>CI (Common Interface)</b>                  (when used with MPEG-2 decoder)</p>	<p>2 slots for simultaneously accepting 2 CA module with EN50221 specification.                  Modules can be inserted/removed from the opening on the top of the device.</p>

<b>SPI Interface</b> (optional only together with MPEG-2 decoder alternative to ASI interface)		(synchron parallel interface) LVDS	
Input	impedance:	100 Ohm	
	input level:	100mV.. 2V <sub>PP</sub> (LVDS)	
	connection:	25 pin D-Sub	
Output	output impedance:	100 Ohm	
	difference output level:	typ. 350mV <sub>PP</sub>	
	connection:	25 pin D-Sub	
input and output are using the same socket and can be switched with internal software			
<b>ASI Interface</b> (optional only together with MPEG-2 decoder alternative to SPI interface) (when used with MPEG-4 decoder)		(asynchron serial interface) acc. to EN50083-9	
Input	input level:	500 .. 880m V <sub>PP</sub>	
	connection:	BNC socket	
	impedance:	75 Ohm	
Output	output level:	typ. 800mV <sub>PP</sub>	
	connection:	BNC socket	
	output impedance:	75 Ohm	
Note: Only one of the two interfaces can be connected at a time			

<b>DVI Interface</b> (optional when used with MPEG-4 decoder)		output impedance:	100 Ohm
		difference output level:	typ. 1 V <sub>PP</sub>

<b>COFDM demodulator</b> (optional)	(per ETS 300744)
Channel bandwidth	6MHz, 7MHz and 8MHz
FFT mode	2k (1705 carrier), 8k (6817 carrier)
Modulation scheme	QPSK, 16QAM, 64QAM
Hierarchical modes	$\alpha=1, \alpha=2, \alpha=4$
Guard interval	1/4, 1/8, 1/16, 1/32
Code rates	1/2, 2/3, 3/4, 5/6, 7/8
Reed-Solomon decoder	204, 188, 8
Interleaving	convolutional interleaver (Forney)
Descrambling	
Automatic adjustment of modulation parameters	analysis of TPS information

<b>COFDM measuring parameters</b>	(per ETR 290)
Bit error rate	
VBER	$10^{-2}$ to $10^{-8}$ (bit error rate after Viterbi or before Reed-Solomon)
CBER	$10^{-1}$ to $10^{-6}$ (bit error rate before Viterbi)
Signal-to-noise ratio (S/N)	(Instrument delivered before June 2009)
Measuring range	3 - 24dB
Resolution	0.1 or 1dB
Modulation error rate (MER)	(Instrument delivered later June 2009)
Measuring range	6 - 34dB
Resolution	0.1 or 1dB
IQ analysis	via constellation diagram
Modes	- all carriers superimposed - single carrier display

<b>NICAM decoder</b> (optional)	(per ETS 300163)
Television standards	B/G, D/K, L, I
NICAM audio carrier	5.85MHz (B/G, D/K, L) 6.552MHz (I)
Roll-off factor	0.4 (B/G, D/K, L) 1.0 (I)
Demodulator	DQPSK
Gross data rate	728kbit/s
De-emphasis	J 17
<b>NICAM measuring parameters</b>	
Bit error rate	$2.51 \times 10^{-2}$ to $4.10 \times 10^{-6}$
<b>ADR decoder</b> (optional)	per ADR specification of SES
ADR audio carrier	6.12 – 8.46MHz
Audio decoding	MPEG1 Layer2
Demodulator	DQPSK
Gross data rate	256kbit/s
<b>ADR measuring parameters</b>	
Viterbi min. distance	4800 - 5300
<b>C/N measurement in SAT range</b> (optional)	
Measuring range	8 - 22dB
Resolution	0.1dB or 1dB
Accuracy	$\pm 1.5$ dB
<b>S/N measurement in TV range</b> (optional) rated according to CCIR 569	
Measuring range	40 - 52dB
Resolution	0.1dB or 1dB
Accuracy	$\pm 1.5$ dB
<b>S/N measurement of external video signal</b> (optional) rated according to CCIR 569	
Measuring range	40 - 58dB
Resolution	0.1dB or 1dB
Accuracy	$\pm 1.5$ dB
<b>SCOPE</b> (optional)	Oscillographic display of TV scanning lines in real time
Sources	SCART (FBASin), SAT analog, TV analog
Line selection	1-625
	Zoom function
	Hum measurement
Accuracy	Black level: $\pm 3\%$ White level – blanking level: $\pm 5.0\%$
<b>SCART</b>	CCVS input (1V <sub>pp</sub> at 75 Ohm) CCVS output (1V <sub>pp</sub> at 75 Ohm)  RGB output (0.7V <sub>pp</sub> at 75 Ohm) (active only in analysing mode, constellation diagram and teletext display)  SAT baseband output (1V <sub>pp</sub> at 75 Ohm) unclamped AF stereo input/output (1V <sub>pp</sub> at 600 Ohm)
<b>RS 232 interface</b>	9-pin Sub-D socket
<b>Station memory</b>	200
<b>Data storage</b>	24500 bytes

<b>Image reproduction</b>		through 5.5" TFT colour display Resolution: 320 x 240 with back lighting  Software version V15.27 and higher through 5.7" TFT colour display Resolution: 640 x 480 with back lighting
<b>Sound reproduction</b>		through integrated loudspeaker or stereo headphone jack
<b>LNB feed</b>		voltage, adjustable from 10V to 20V in 0.1V increments, short circuit-proof $I_{max} = 500mA$
<b>Remote supply</b>		2 voltages, adjustable from 10V to 20V in 0.1V increments, short circuit-proof $I_{max} = 500mA$  COFDM 5V permanent too (delivery later August 2004)
<b>AC overlay (22kHz)</b>		$V_{pp} = 0.6V$
<b>DiSEqC control</b>		Version 1.0, version 1.2, version 2.0 and UNICABLE
<b>Current measurement to LNB and remote supply</b>	Measuring range: Resolution: Measuring accuracy:	5 - 500mA 1mA $\pm 2\%$ of final value
<b>Printer</b>		thermal printer speed of approx. 2 lines per second
<b>Power supply</b>	Line External 12V  Storage battery	100 to 240 Vac; 50 to 60 Hz (LED check) DC 11,5V to 13,5V approx. 3A <b><u>Delivery later Serial No. 50001</u></b> DC 11,5V to 15V approx. 3A  2x12V/2.2Ah (lead battery) with integrated charger (2nd optional) charging time approx. 3 h, operating time with 1 battery approx. 0.5h, with 2 batteries approx. 1.5h automatic cutout in battery mode as protection against exhaustive discharge  <b><u>Delivery later Serial No. 50001</u></b> 12V/4.5Ah (NiMH) with integrated charger operating time approx. 1.5h to 2h depending on operating status charging time approx. 3 h automatic cutout in battery mode as protection against exhaustive discharge  <b><u>For devices with Li-ion batteries (optional)</u></b> 14.4V/6.75Ah (NiMH) with integrated charger operating time approx. 2.5h to 5h depending on operating status charging time approx. 6 h automatic cutout in battery mode as protection against exhaustive discharge
<b>Electromagnetic compatibility</b>		to EN 61000-6-1 and EN 61000-6-3
<b>Protection</b>		class II to VDE 0411
<b>Dimensions (W x H x D)</b>		365 x 150 x 285 (mm)
<b>Weight</b>		approx. 6.7 kg with 1 storage battery

Chapter 3

Control and connection elements, pin configurations

3.1 Front panel

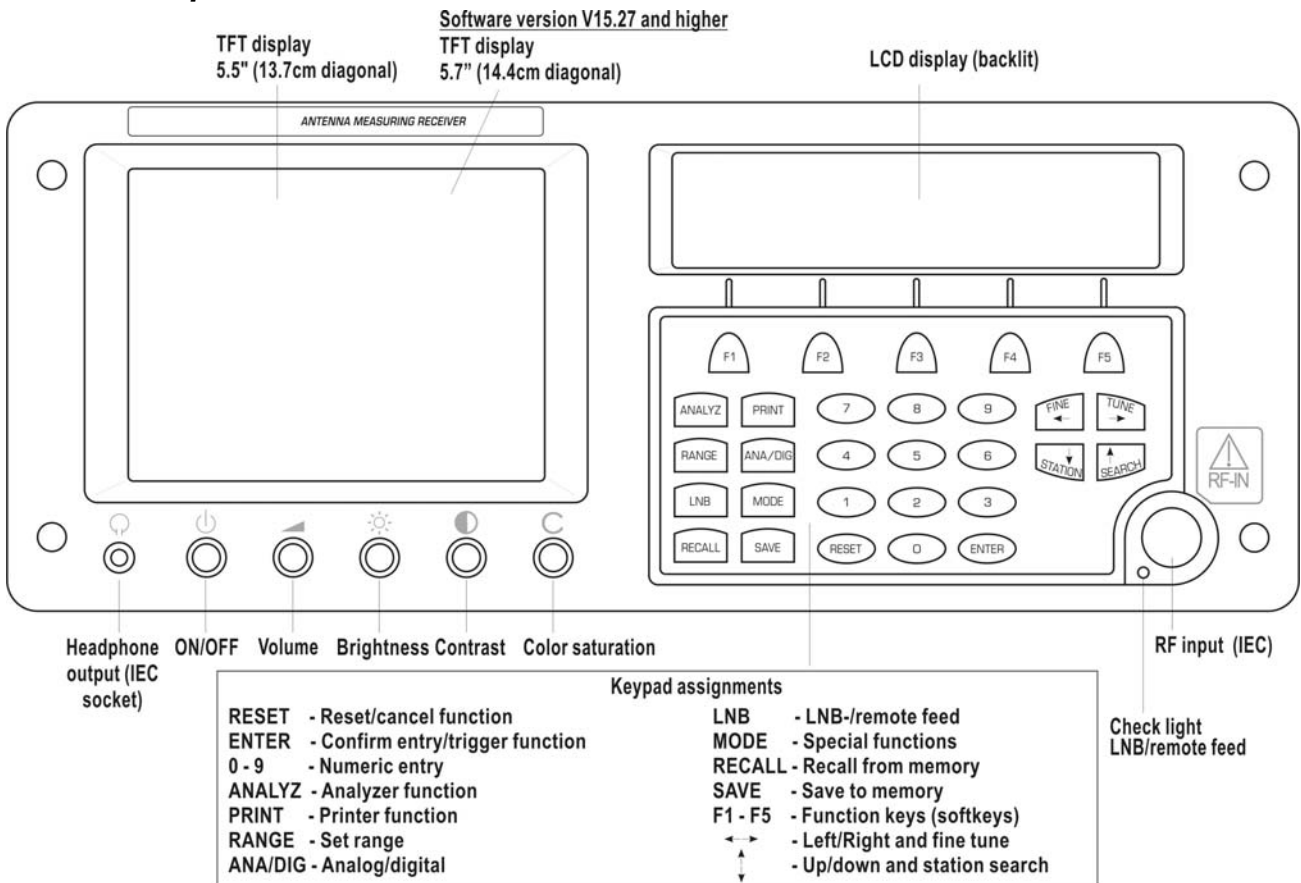

3.2 Left side view

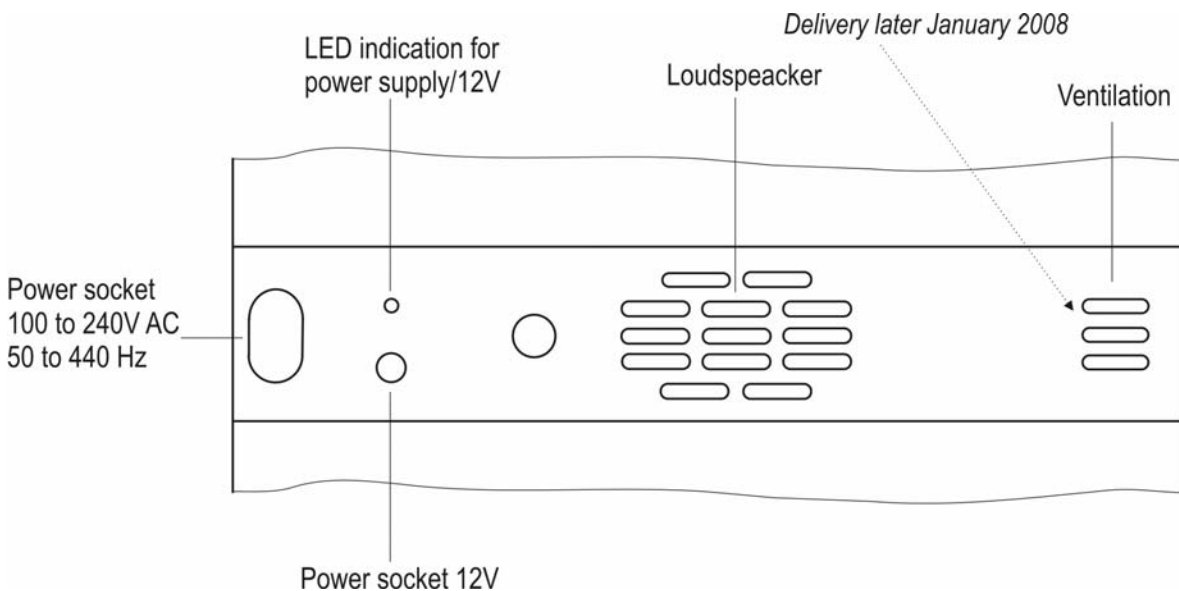

### 3.3 Right side view

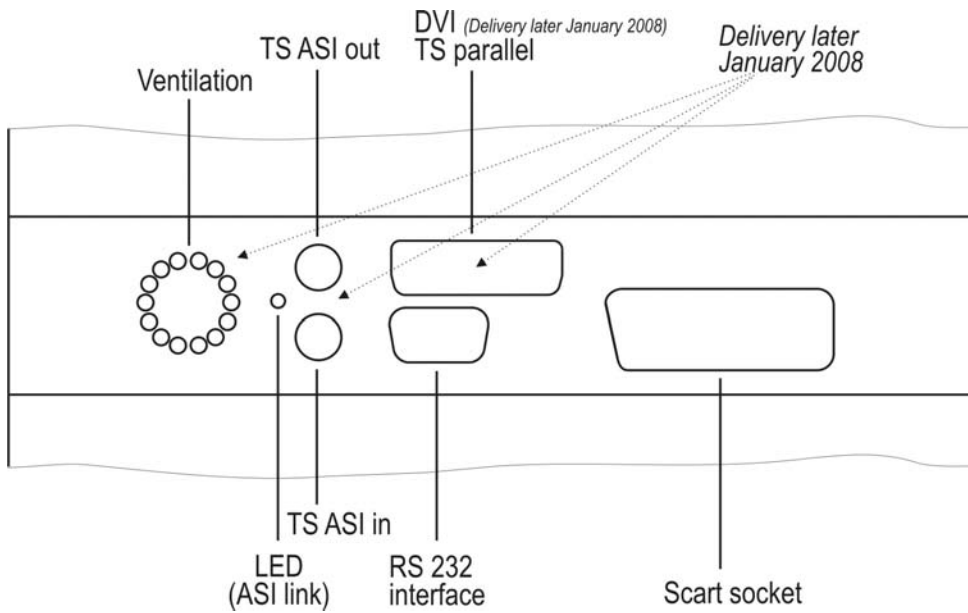

### 3.4 Rear panel

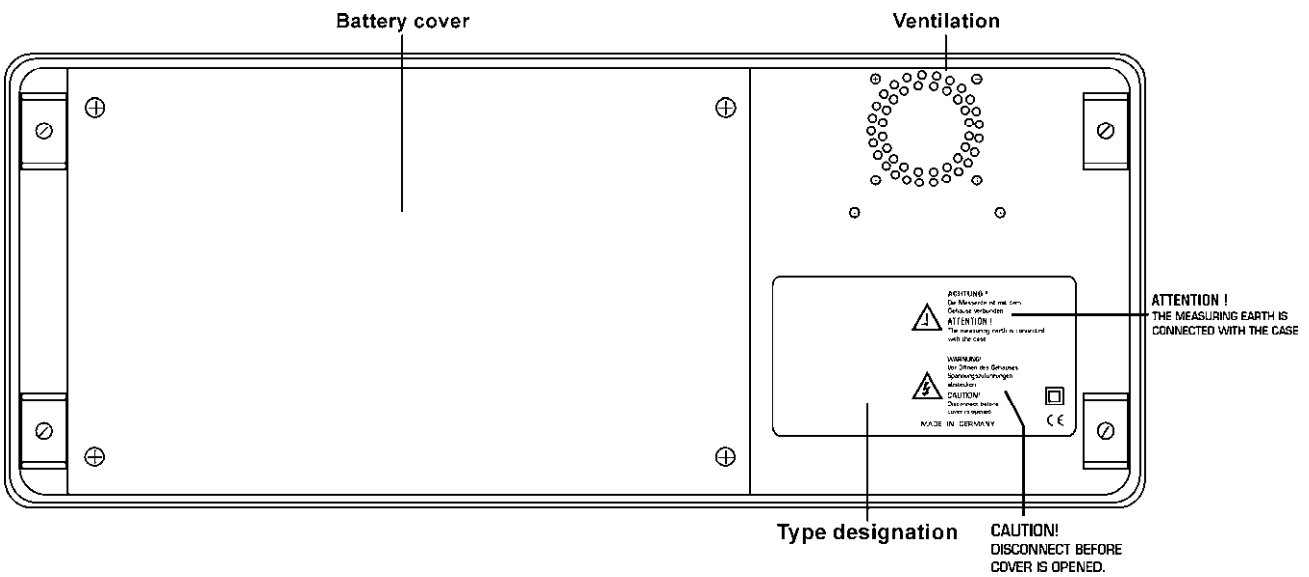

### 3.5 Scart socket (EU AV)

Scart socket per DIN EN 50 049

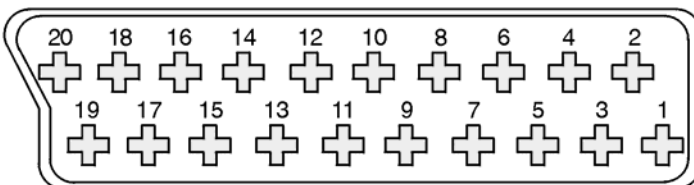

- |                          |                           |                         |
|--------------------------|---------------------------|-------------------------|
| 1 = Audio output right   | 8 = Switching voltage 12V | 15 = Red (output)       |
| 2 = Audio input right    | 9 = RGB ground            | 16 = Blanking (output)  |
| 3 = Audio output left    | 10 = not used             | 17 = Video ground       |
| 4 = Audio chassis ground | 11 = Green (output)       | 18 = Video ground       |
| 5 = RGB ground           | 12 = not used             | 19 = Video output       |
| 6 = Audio input left     | 13 = RGB ground           | 20 = Video input        |
| 7 = Blue (output)        | 14 = RGB ground           | Screen = Chassis ground |

### 3.6 RS 232

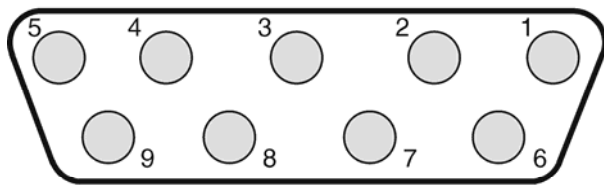

- 1 = NC
- 2 = RX Data
- 3 = TX Data
- 4 = NC
- 5 = GND
- 6 = NC
- 7 = NC
- 8 = NC
- 9 = NC

### 3.7 TS parallel

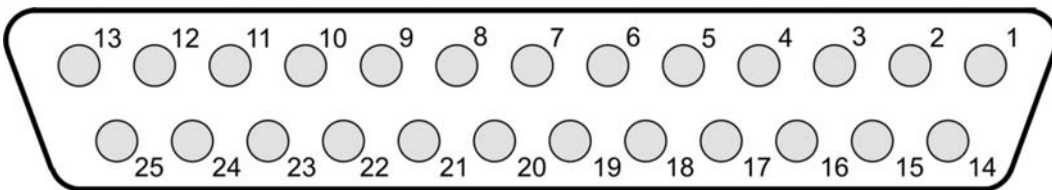

- |                    |                   |               |
|--------------------|-------------------|---------------|
| 1 = Clock A        | 9 = Data 1 A      | 17 = Data 6 B |
| 2 = System GND     | 10 = Data 0 A     | 18 = Data 5 B |
| 3 = Data 7 A (MSB) | 11 = DVALID A     | 19 = Data 4 B |
| 4 = Data 6 A       | 12 = PSYNC A      | 20 = Data 3 B |
| 5 = Data 5 A       | 13 = Cable Shield | 21 = Data 2 B |
| 6 = Data 4 A       | 14 = Clock B      | 22 = Data 1 B |
| 7 = Data 3 A       | 15 = System GND   | 23 = Data 0 B |
| 8 = Data 2 A       | 16 = Data 7 B     | 24 = DVALID B |
|                    |                   | 25 = PSYNC B  |

### 3.8 12V power supply

Extra-low voltage jack per DIN 45 323

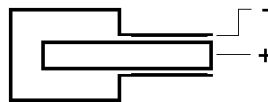

### 3.9 Headphone jack

3.5mm stereo jack

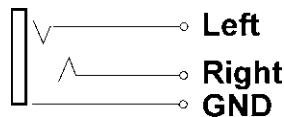

### 3.10 DVI Output



- |                              |                               |                            |
|------------------------------|-------------------------------|----------------------------|
| 1 = T.M.D.S. Data 2-         | 11 = T.M.D.S. Data 1/3 Shield | 21 = n.c.                  |
| 2 = T.M.D.S. Data 2+         | 12 = n.c.                     | 22 = T.M.D.S. Clock Shield |
| 3 = T.M.D.S. Data 2/4 Shield | 13 = n.c.                     | 23 = T.M.D.S. Clock+       |
| 4 = n.c.                     | 14 = +5V Power                | 24 = T.M.D.S. Clock-       |
| 5 = n.c.                     | 15 = GND                      |                            |
| 6 = DDC Clock                | 16 = Hot Plug Detect          | C1 = n.c.                  |
| 7 = DDC Data                 | 17 = T.M.D.S. Data 0-         | C2 = n.c.                  |
| 8 = n.c.                     | 18 = T.M.D.S. Data 0+         | C3 = n.c.                  |
| 9 = T.M.D.S. Data 1-         | 19 = T.M.D.S. Data 0/5 Shield | C4 = n.c.                  |
| 10 = T.M.D.S. Data 1+        | 20 = n.c.                     | C5 = n.c.                  |

## Chapter 4

### Startup

---

#### 4.1 Mains operation

---

**Important!**  *The instrument will not function if the power plug is removed.*

---

Connect to the power supply using the socket on the left side of the instrument. A green LED indicates that power is available.

#### 4.2 Battery operation

##### 4.2.1 NiMH battery operation (battery charge display using battery symbol)

(Unit deliveries starting from serial number 50001)

One NiMH battery is included in the delivery of this instrument. The instrument has an integrated battery recharger and is specifically wired to prevent a total discharge or overcharge of the battery.

##### **Storing the battery at temperatures under 10°C:**

Because the chemical reactions in an installed battery change at low temperatures, battery packs that have been stored at temperatures lower than 10°C are no longer able to perform to their full capacity. The minimum voltage required for the operation of the instrument will fall below the specified value sooner, this will also affect the battery calibration (the battery may need to be calibrated again).

After storage at less than 10°C, it is recommended that the instrument is initially connected to a power supply for approx. 20-30 minutes, so that the battery can be refreshed.

This is particularly important with high LNB current and by digital operation.

##### 4.2.1.1 Changing the NiMH battery (Type HHR450AB F10)

Switch off the instrument and disconnect the power plug when removing batteries.

Open the battery cover by removing the four screws on the back of the device.

Unlock and remove the battery pack cable plug. Loosen the screws of the battery retaining clip.

After changing the battery, attached everything in the reverse order and reconnect the battery pack cable plug.

**Important!**  *A calibration run must be performed after every battery change. See the next chapter.*

##### 4.2.1.2 Charging the NiMH battery

The battery is automatically recharged when the instrument is connected to the power supply. This occurs even if the instrument is switched off. A full charge takes about 3 hours (if the instrument is switched off or standby mode).

The automatic charger ensures an optimum charge and prevents battery damage.

The power supply units contain a battery management component that measures the charge status of the batteries by registering the charging and discharging current.

The charge status is continually measured from 0% to 100% and displayed with a correspondingly charged battery in the display.



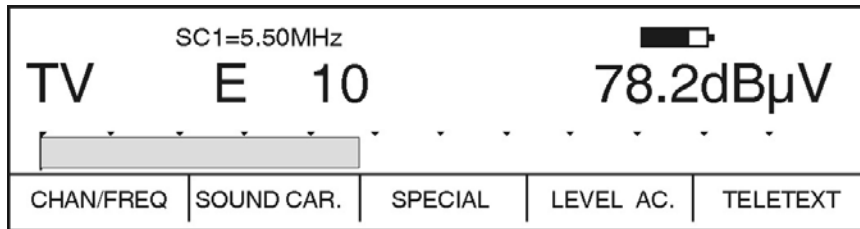

---

**Important!** ⚠ The dB indicator level (MODE 84) must be set to normal level; otherwise, the battery charge is not visible when measuring levels.

---

### Calibration run

A calibration run must be performed after every battery change. To do so, the battery must first be fully charged (fully charged battery symbol). To check the battery charge, the instrument must be switched on and in standby mode (no station tuned in).

When the battery charge is fully charged, the device must be disconnected from the power supply to start the discharging process. Since available battery capacity depends on the discharge current, you should select the most frequently used operating condition of the device for discharging (e.g. call up an digital television channel).

The battery is now discharged until the battery is empty. The battery symbol is displayed both empty and without the bottom section to indicate this status. At this time, the actual battery capacity available is detected and stored.

The battery charge measurement is always recalibrated when the instrument is normal operation and the end points are reached (battery empty or full).

---

The charge or discharge rate and the battery quality can also be displayed in special program **MODE 91**. A manual setting of the battery charging situation is also possible. Please see chapter - **Battery charge display**.

#### 4.2.1.3 Discharge warning (NiMH battery)

To avoid a total discharge of the battery, a warning message appears when battery capacity drops below the first discharge level (Battery without bottom section).

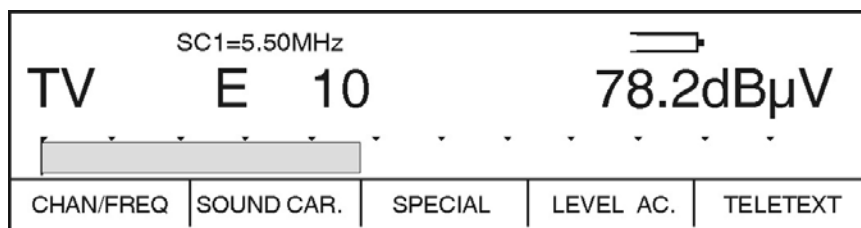

Any measurements in progress can still be completed. Immediately recharge the battery afterwards.

Note that the device will automatically switch to standby mode once the second discharge level is reached. The display shows:

**LOW ACCU ! PLEASE CHARGE**

If the device is used further after this message, it will automatically switch off once the third discharge level is reached. All operating functions are disabled. This happens to prevent the battery from fully discharging. In this case, the battery must be recharged as soon as possible.

The device will function normally once the battery is recharged. The device can be used again immediately by connecting it to the power supply.

#### 4.2.2 Lithium-Ion battery operation (Option) (battery charge display using battery symbol)

The operation and display are the same as with the NiMH battery. The lithium ion battery has a higher capacity and because of its chemistry, the charging behaviour (memory effect) does not affect the capacity or service life of the battery. The following warnings are inapplicable warnings or additional warnings.

##### 4.2.2.1 Changing the Lithium-Ion battery (Type Pana CGR 18650)

Switch off the instrument and disconnect the power plug when removing batteries.

Open the battery cover by removing the four screws on the back of the device.

Loosen the three screws of the battery holder. Unlock and remove the battery pack cable plug. Loosen the screws of the battery retaining clip. Remove the battery along with the battery holder. Then remove the battery from the holder. After changing the battery, reattach everything in the reverse order and reconnect the battery pack cable plug.

**Important!**  **Be careful to avoid damaging the lithium ion battery. Damaged batteries cannot be used. Dispose of damaged batteries properly. Use only original batteries provided by the manufacturer. There is a risk of fire if batteries are damaged or if proper internal safety devices are missing.**

**Important!**  **A calibration run must be performed after every battery change. See the next chapter.**

#### 4.2.3 Lead battery operation (battery charge display using percentage)

One battery is included in the delivery of this instrument. Battery life can be doubled by using a second battery. The instrument has an integrated battery recharger and is specifically wired to prevent a total discharge or overcharge of the battery.

##### 4.2.3.1 Inserting the lead battery

**Important!**  **Use only quick-charge batteries with a max. initial charging voltage of > 0.8A.**

Disconnect the power plug when inserting or removing batteries.

Open the battery cover by removing the four screws on the back of the device.

The battery compartment is on the rear left side of the device directly on the back panel (Type 12V/2.2Ah).

Loosen the screws of the battery retaining clip.

Insert the battery.

**Important!**  **Connect the **positive terminal** (red cable) first and then the **negative terminal** (blue cable). Please note the marks +/- on the yellow stickers in the battery box.**

**Important!**  **Don't squeeze the cables when inserting the battery.**

Tighten the battery retaining clip and replace the cover.

**Important!**  **If a different number of batteries is used, **special program 91** must be set accordingly.**

**Important!**  **A calibration run must be performed after every battery change. See the next chapter.**

##### 4.2.3.2 Recharging the lead battery (delivery later January 2003)

The battery is automatically recharged when the instrument is connected to the power supply.

This occurs even if the instrument is switched off. A full charge takes about 3 hours.

The automatic charger ensures an optimum charge and prevents battery damage.

The power supply units contain a battery management component that measures the charge status of the batteries by registering the charging and discharging current.

The charge status is continually measured from 0% to 100% and is indicated in the display (eg, A: 95 %).

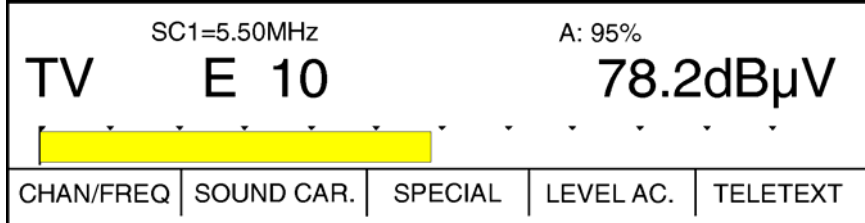

**Important!** ⚠ The dB display size (MODE 84) must be set to normal in order to see the battery charge.

**Calibration run**

A calibration run must be performed after every battery change. To do so, the battery must first be fully charged (battery charge 100%). The device must be switched on for the battery charge to be visible on the display.

When the battery charge reaches 100%, the device must be disconnected from the power supply to start the discharging process. Since available battery capacity depends on the discharge current, you should select the most frequently used operating condition of the device for discharging (e.g. call up an analog television channel).

The battery is now discharged until the battery charge displayed is 0%. When the battery charge is 0% the actual battery capacity available is detected (this is displayed in the MODE 91 special program). The values for full (100%) and empty (0%) are displayed in inverted type.

The battery charge measurement is always recalibrated when the instrument is operated further and the end points are reached (0% or 100%).

The charge or discharge rate can also be displayed using special program **MODE 91**.

**4.2.3.3 Discharge warning (lead battery)**

To warn the device operator of a total discharge of the battery, a warning message appears when battery capacity drops below the first discharge level (A: 0% displayed inverted).

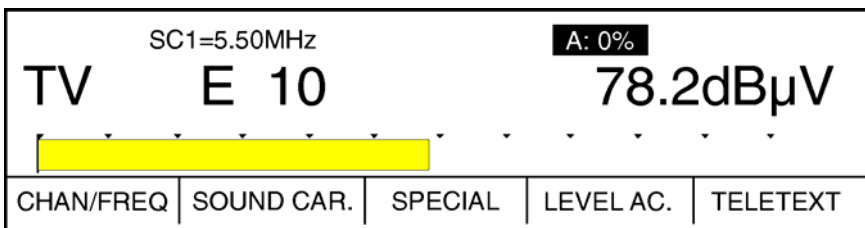

Any measurements in progress can still be completed. Immediately recharge the battery afterwards.

Note that the device will automatically switch off once the second discharge level is reached. All operating functions are disabled to prevent a total discharge of the battery.

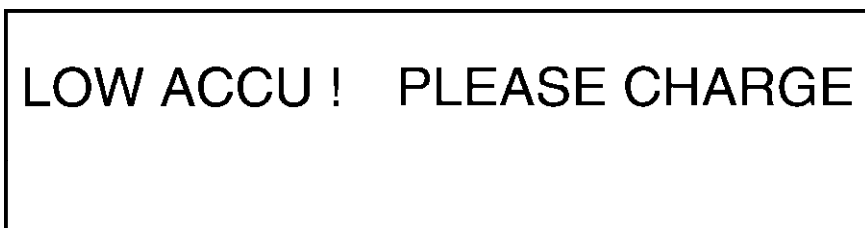

The device will function normally once the battery is recharged.

The device can be used again immediately by connecting it to the power supply.

### 4.3 External 12V power supply

The measuring instrument can also function with an external 12V power supply (eg, connecting it to the cigarette lighter receptacle of a vehicle). This also charges the internal battery. A suitable adaptor cable is used (contact configuration: see "Pin Configurations" chapter, section 7) to establish a connection from the voltage source to the instrument socket ("Pin Configurations" chapter, section 2).

---

**Important!** ⚠ *Maximum external voltage: 15.0V<sub>DC</sub> (for device with lead battery: 13.5 V<sub>DC</sub>)*

---

**Important!** ⚠ *Never connect the device to both an external 12V power supply and the standard power supply.*

---

## Chapter 5

### Analog level measurement and video check

Press the **ANA/DIG** key to switch between analog and digital reception.

Use the enclosed measuring cable to connect the instrument with the device to be tested.

**Important!**  Do not feed high external voltages to the RF input of the instrument. External voltages exceeding  $60V_{eff}$  will destroy the input circuits of the instrument.

The instrument is turned on with the push switch. The display shows the last range setting:

TV		SC1= . MHz	E .. ANA		STD: B/G
					<b>dB<math>\mu</math>V</b>
					B/G
CHAN/FREQ	SCART	MONITOR			LCD-BACKL.

**Important!**  A high level acting on the input of the instrument while it is operating may cause an overload and an incorrect level display. This can also occur if the measuring cable is disconnected and then quickly reconnected.

**Solutions!**

- Turn the instrument off and then back on and tune to the station again.
- Press the **RESET** key and tune to the relevant station again.
- Use the range keys to switch over to a different range and then tune to the station again.

The results in the display can be printed out during all measurements.  
- See Chapter on Printer Functions -

#### 5.1 Selecting the range

Press the **RANGE** key and the following is displayed:

<b>SELECT RANGE</b>				
FM	VHF-S	VHF/UHF	SAT	REV./IF
F1	F2	F3	F4	F5

Use the function keys (F1-F5) to select the desired range.

#### 5.2 Remote supply (from software version xx.10) (5 V remote supply for unit deliveries startign from August 2004)

In the UKW, VHF-S, VHF-UHF and return channel ranges, a remote supply can be switched on using the LNB key.

Just as in the SAT range, DC current is supplied to the RF input socket.

It can be set between 10V and 20V. When the COFDM is used for measurements in the digital range, the voltage is maintained at 5V since antennas for this range can only be supplied with 5V. If the remote supply is activated, the red remote supply LED next to the RF input socket lights up.

---

**Important!**  *The remote supply must only be activated in special cable systems that require a remote supply. It can damage the connected equipment and antenna jack of other cable systems.*

---

### 5.2.1 Setting the remote supply

After selecting the range (UKW, VHF-S, VHF-UHF or return channel), press **LNB**.

The following menu appears in the function key row:



Once you have pressed **15.0V** (F2) or **5.0V** (F2) or **15.0V** (F4), the remote supply is activated and the function field 15.0V or 5.0V is displayed inverted.

Using 15.0V (F4), 15V can also be activated for devices equipped with software version Vxx.17a or higher in COFDM modulation (a confirmation prompt appears so that 15V is not unintentionally activated). In other cases, in which 15V has been selected, you can use **STATION** ↓ and **SEARCH** ↑ to adjust the remote supply in 0.1V increments from 10V to 20V. The confirmation prompt also appears in the RETURN CHANNEL range so that 15V is not unintentionally activated.

The adjusted voltage will appear in the function key display. Pressing **EXIT** or **ENTER** or **LNB** will return to the previous menu.

The current selection will remain on until it is changed by the operator or until the instrument is switched off. Even when you change to COFDM operating mode, the remote supply is switched off for safety reasons so that excessive voltage is not unintentionally applied to the antenna.

To switch off the remote supply, press **15.0V** (F2) or **5.0V** (F2) or **15.0V** (F4), which is displayed inverted, again. The function key is then displayed normally.

The selected remote supply voltage is now supplied to the RF input socket when a station is selected or during the setting process.

As soon as an RF input socket has remote supply voltage, the red remote supply LED lights up, and the remote supply is shown in the top line of the display.

The short circuit and external voltage monitoring, as well as the current measurement feature functions the same way as for LNB voltage in SAT range.

---

**Important!**  *The remote supply status (on or off) is not accepted in the tuner memory and therefore cannot be set by the documentation software (offered by the manufacturer).*

---

### 5.3 FM broadcasting range (with RDS - delivery later June 2003)

Press the **FM** key (F1) and the following is displayed:

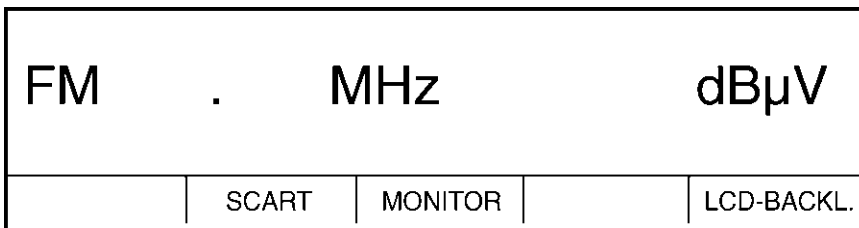

Enter the frequency with the numeric keypad. The spaces before and after the decimal point determine the number of digits you must enter.

Press the **RESET** key to delete an incorrect entry.

Press **ENTER** to set the station and start the measurement. Example:

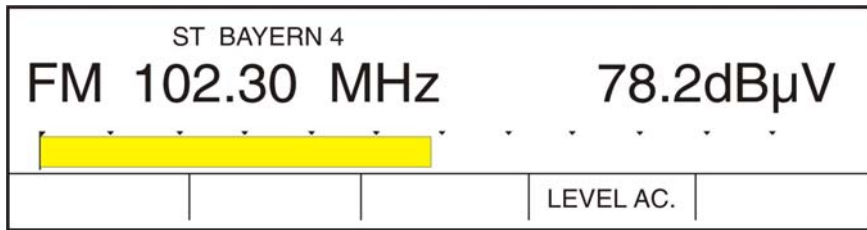

The result appears in the display as a corrected final value in dBµV.

If the instrument receives a stereo signal, the **ST** message is displayed as well.

Next to the stereo indication (ST) the FM station name is indicated (appr. BAYERN 4). If the station does not transfer RDS data or if the signal is disturbed the display shows **NO RDS**.

Press the **LEVEL AC.** key (F4) to activate the acoustic level trend indicator. The incoming sound is switched off. The acoustic level trend signal can be changed using the volume control.

The audio frequency of the level trend signal rises as the level increases and drops as the level decreases. This makes it possible to find the maximum of a received signal (eg, when locating an antenna).

Press the **LEVEL AC.** (F4) again to switch off the acoustic level trend indicator. The incoming sound is switched on again.

To check an FM stereo station, you can connect stereo headphones to the socket on the front of the instrument. (see Pin Configurations chapter)

Enter a new frequency and then press **ENTER**.

#### 5.4 Television ranges (terrestrial and broadband cable ranges)

To select a TV station, enter the channel number or frequency on the numeric keypad.

Press the **CHAN/FREQ** key (F1) to select which input mode you want to use.

The channel or frequency can be entered once the range has been selected.

Depending on the selected range, the display shows **E** for a European channel or **S** for a special channel.

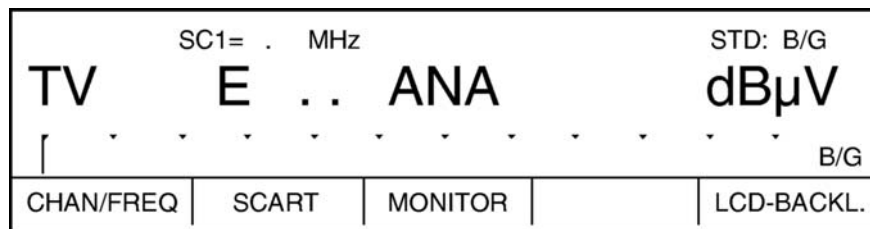

Enter a channel or frequency and then press **ENTER**. This sets the station, initiates the measurement and displays a TV picture.

The result appears in the display as a corrected final value in dBµV.

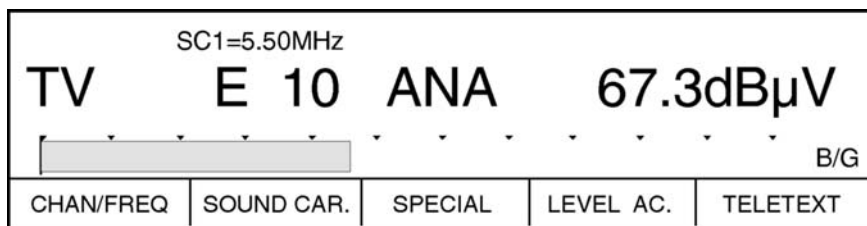

Press the **LEVEL AC.** key (F4) to activate the acoustic level trend indicator. The TV sound is switched off. The acoustic level trend signal can be changed using the volume control. The audio frequency of the level trend signal rises as the level increases and drops as the level decreases. This makes it possible to find the maximum of a received signal (eg, when locating an antenna).

Press the **LEVEL AC.** key (F4) again to switch off the acoustic level trend indicator. The TV sound is switched back on.

Press **ENTER** after entering a new frequency or channel.

5.4.1 Setting the colour standard (PAL, SECAM, NTSC)

The instrument automatically recognizes PAL or SECAM transmissions and sets itself accordingly. The NTSC colour standard is linked with the M/N TV standard in the terrestrial range (also with IF measurement and monitor mode).

If the instrument is set to the M/N TV standard, only NTSC transmissions can be displayed.

The following is displayed after tuning to a station:

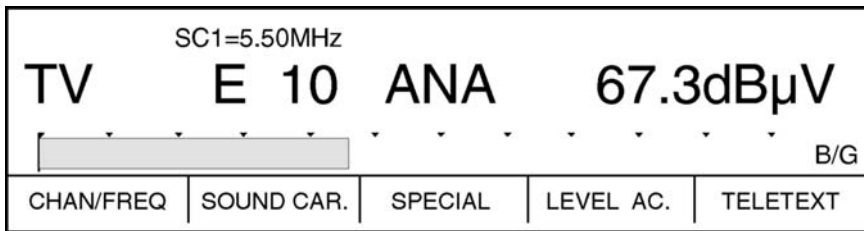

Use the **SPECIAL** key (F3) to call up menu in which the **TINT -** (F1) and **TINT +** (F4) keys appear. These keys allow you to adjust the phase (tint) in the NTSC colour standard. The phase setting is stored until the instrument is switched off.

The TINT setting returns to the preset value (phase = 0°) when the instrument is switched on again.

5.4.2 Sound carrier level measurement, SC2 listen (optional stereo and dual sound indicator)

To measure the sound carrier level, first enter the TV channel (or frequency) and then start the measurement by pressing the **ENTER** key.

Press the **SOUND CARRIER** key afterwards.

The following menu appears:

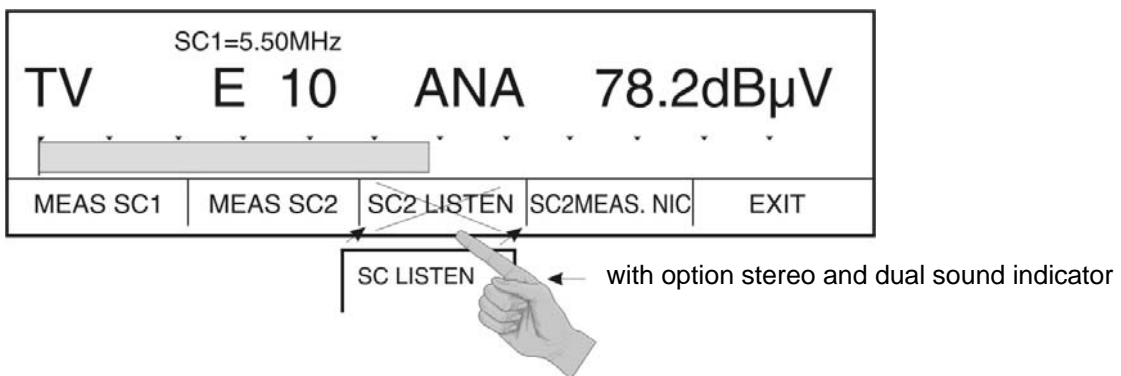

Selecting the **MEAS SC1** key (F1) displays the level of sound carrier 1. The **SC1** designation before the displayed level value indicates the selected measurement. Press the **MEAS SC1** key (F1) again and the picture returns and the measured level of the video carrier is displayed.

Devices delivered from May 2006 feature the MODE 81 special program which allows you to switch from absolute measurement to difference measurement. Difference measurement shows the difference between the video carrier level and the sound carrier level. This is indicated by the sign in front of the level value (e.g. -15.0 dBµV).

Selecting the **MEAS SC2** function key (F2) displays the level of sound carrier 2.



The distance of SC1 and SC2 to the video carrier depends on the TV standard.

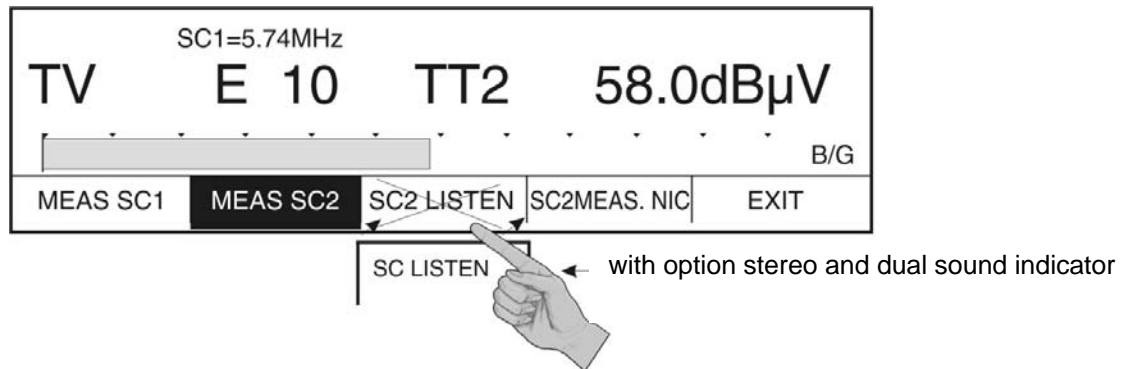

The **SC2** designation before the displayed level value indicates the selected measurement. Press the **MEAS SC2** function key (F2) again and the measured level of the video carrier is displayed.

Select the **SC2 LISTEN** key (F3) to hear the sound carrier 2 on the loudspeaker or through headphones. During this time the function key appears inverted. Press the **SC2 LISTEN** key (F3) again to hear the normally audible sound carrier 1.

If the TV stereo/dual sound option is installed, the TV sound standard (mono, stereo or dual sound) is displayed next to the sound carrier frequency. In addition, the **SC LISTEN** (F3) function key opens a submenu.

In this menu, the (F1) to (F3) function keys are used to select the following functions:

- SC1 LISTEN:** The sound signal from sound carrier 1 is output to the loudspeaker and to the left and right channels of the headphone and SCART sockets. (default setting).
- TT2 LISTEN:** The sound signal from sound carrier 2 is output to the loudspeaker and to the left and right channels of the headphone and SCART sockets.
- STEREO:** The true stereo signal is output to the headphone and SCART sockets. The loudspeaker reproduces the right channel of the stereo signal.

These settings remain in effect until the instrument is switched off. When it is switched on, the instrument is set to the default setting, **SC1 LISTEN**.

Press the **SC2MEAS.NIC** function key (F4) again and the level of the NICAM sound carrier is displayed. The distance between the video carrier and the NICAM sound carrier is 5.85 MHz (for standard I: 6.552MHz). The **NIC** designation before the displayed level value indicates the selected measurement. Press the **SC2MEAS.NIC** key (F4) again and the measured level of the video carrier is displayed.

Press the **EXIT** key (F5) to close the sound carrier menu.

## 5.5 Satellite range

### 5.5.1 Frequency input (1. SAT-IF or direct RF transponder frequency)

Either the first SAT-IF or the direct transponder frequency (RF) can be entered in the SAT range.

Press the **SAT** key (F4) to measure the satellite level.

The following display will appear:

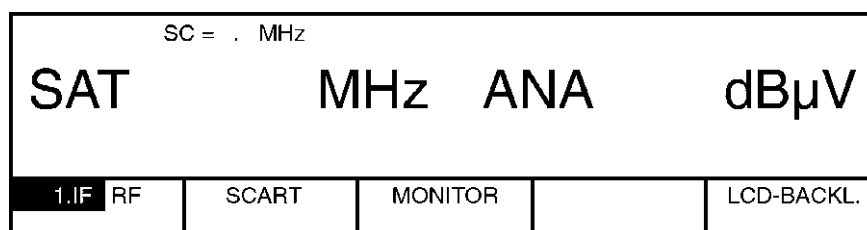

The display indicates that you must enter the 1st SAT-IF in MHz.

To enter the transponder frequency (RF), press **1. IF/RF** (F1) to switch to the correct mode.

When you press **1. IF/RF** (F1), the following appears in the display:

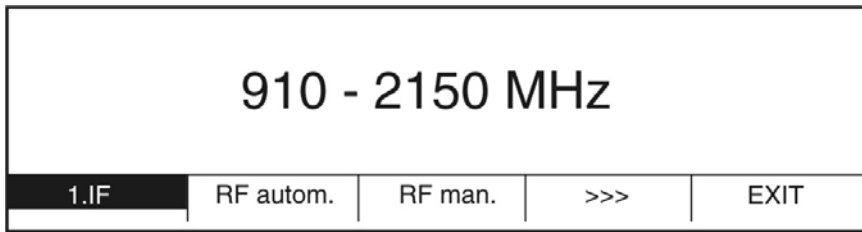

Use the function keys to select **1. SAT-ZF**, **RF automatic** or **RF manual** or other menu options. The selected operating model is displayed inverted.

If you select **RF autom.**, the following appears in the display:

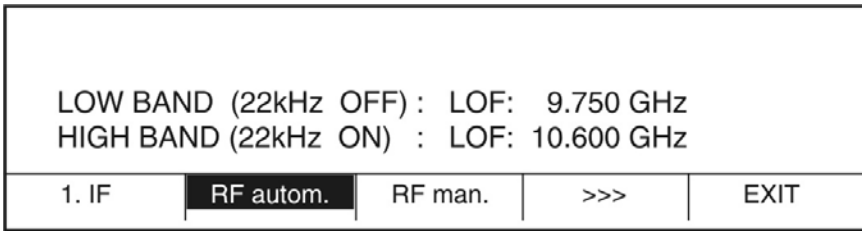

In this mode, the 22kHz modulation switching criterion is **permanently set** when the LNB local oscillator frequency is used.

When using LOW BAND (22kHz off), a local oscillator frequency (LOF) of 9,750GHz is used.

When using HIGH BAND (22kHz on), a local oscillator frequency (LOF) of 10,600GHz is used.

When you use the number keys to enter the transponder frequency, LOW BAND (22kHz off) is used for a frequency up to 11,700GHz and HIGH BAND (22kHz on) is used for a frequency over 11,700GHz.

Even if LNB supply is not switched on, you can use HIGH BAND with 10,600GHz LOF if you enter a transponder frequency over 11,700GHz.

If you select **RF autom.**, the following appears in the display:



In this mode, the 22kHz modulation switching criterion is **not set** when the LNB local oscillator frequency is used.

You can set the LNB local oscillator frequency as required. Press **LOF >>** (F5) to choose from 3 preset frequencies. You can use the numeric keypad to change one of the frequencies (VARIABLE LOF between 9,000GHz and 12,000GHz).

You must press **ENTER** after entering a frequency using the numeric keypad.

If you select **RF LOW v.** or **RF HIGH v.**, the following appears on the display:

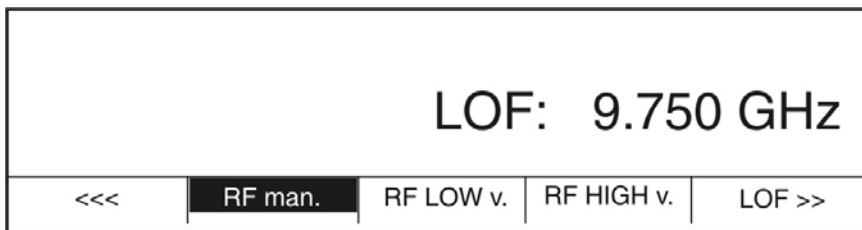

In variable mode, the 22kHz modulation switching criterion is **linked** to the use of the LNB local oscillator frequency and unlike with automatic mode, 22kHz modulation is not activated after the frequency that you have entered. Instead, frequencies are only accepted if they are possible with the previously selected 22kHz modulation (otherwise an error message is displayed, e.g. **FREQUENCY ERROR HIGH BAND IS SET**).

You can set the LNB local oscillator frequency for HIGH BAND and/or LOW BAND as required. Press **LOF >>** (F5) to choose from 2 preset frequencies. You can use the numeric keypad to change one of the frequencies (VARIABLE LOF between 9,000 GHz and 12,000 GHz). You must press **ENTER** after entering a frequency using the numeric keypad. The frequency currently selected is shown on the display.

---

**Important!**  In manual and variable mode, the local oscillator frequency used is not saved in the tuning memory. You must therefore press **RECALL** when tuning to set the local oscillator frequency used when saving on the measuring receiver for the correct transponder frequency to appear in the display.

---

The <<< (F1) or **EXIT** (F5) key returns to the previous menu.

If **RF autom.**, **RF man.**, **RF LOW v.** or **RF HIGH v.** operating mode is selected, all frequencies are displayed and expressed in GHz. The mode is also displayed in the **1.IF/RF** (F1) function key.

**1.IF/RFa** is displayed for **RF autom.** and **1.IF/RFm** is displayed for **RF man.** **1.IF/RFv** is displayed for the remaining operating modes. **RFa**, **RFm** and **RFv** are inverted.

The 1. SAT-IF operating mode is selected in the following example:

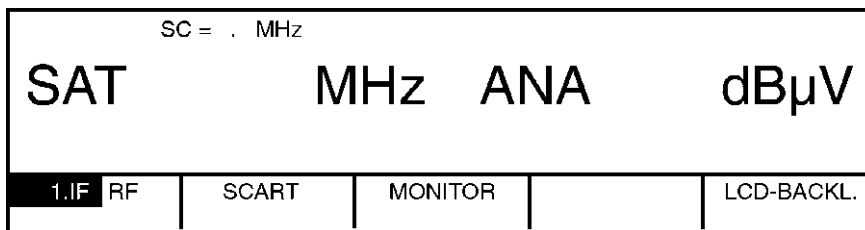

Enter the frequency and then press **ENTER**.

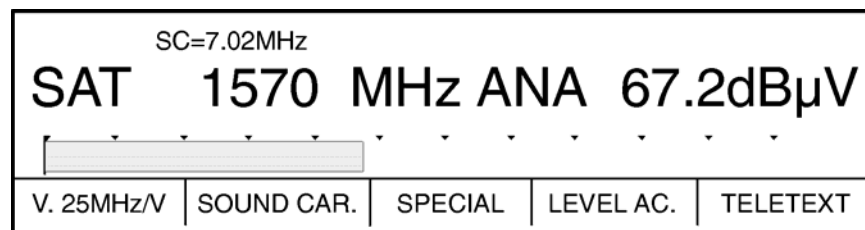

This sets the station and starts the measurement.

The result appears in the display as a corrected final value in dBµV.

**Inverting the video signal:**

Press the **SPECIAL** key (F3) to switch to another menu containing the **VIDEO INV.** function key. This key allows you to invert the video signal in the SAT range (for satellites with positive video modulation).

With the setting is **UNICABLE**, the video signal is automatically inverted.

A positive video modulation is selected if the **VIDEO INV.** function key is displayed inverted.

Press the **VIDEO INV.** key again to switch back to negative video modulation.

**Important!**  The setting is reset to negative video modulation when the instrument is turned on.

If a level greater than 120 dBµV is received by the instrument, the display shows **> 120 dBµ**.

Press the **LEVEL AC.** key (F4) to activate the acoustic level trend indicator. The TV sound is switched off. The acoustic level trend signal can be changed using the volume control.

## 28 **Chapter 5 – Analog level measurement and video check**

The audio frequency of the level trend signal rises as the level increases and drops as the level decreases. This makes it possible to find the maximum of a received signal (eg, when locating a satellite antenna).

Press the **LEVEL AC.** key (F4) again to switch off the acoustic level trend indicator. The TV sound is switched back on.

Enter a new frequency and then press **ENTER.**

Depending on the setting, the **FINE ←** and **TUNE →** keys allow you to detune the frequency in 1MHz or 125kHz increments using **Special Program 72.**

If you push and hold the keys down, detuning continues in decreasing time intervals until the maximum detuning speed is reached after about 2 seconds.

### 5.5.2 *Video deviation*

A video deviation of 16MHz/V or 25MHz/V is transmitted in the SAT range.

The **V. 25MHz/V** key (F1) switches the video deviation to 25MHz/V. If this function is active, the **V. 25MHz/V** is displayed inverted.

Press the key again to reset the video deviation to 16MHz/V. The function key is then displayed normally.

Turn off the instrument and the video deviation returns to its default setting of 16MHz/V.

### 5.5.3 Setting the colour standard (PAL, SECAM, NTSC)

The instrument automatically recognizes PAL or SECAM transmissions and sets itself accordingly.

A function key enables you to switch to the NTSC colour standard in the SAT range. To do so, first tune to a station in the SAT range.

The following is displayed:

SC=7.02MHz				
SAT 1570 MHz ANA 67.2dB $\mu$ V				
[Progress bar]				
V. 25MHz/V	SOUND CAR.	SPECIAL	LEVEL AC.	TELETEXT

Now press the **SPECIAL** key (F3) to switch to the following menu:

SC=7.02MHz				
SAT 1570 MHz ANA 67.2dB $\mu$ V				
[Progress bar]				
VIDEO INV.	SCART	BLANKING.	NTSC	EXIT

Use the **NTSC** key (F4) to switch to the NTSC colour standard in the SAT range. The **NTSC** function key is now displayed inverted. Two additional function keys, **TINT-** and **TINT+**, will appear at the same time.

SC=7.02MHz				
SAT 1570 MHz ANA 67.2dB $\mu$ V				
[Progress bar]				
TINT -	TINT +		<b>NTSC</b>	EXIT

These keys allow you to adjust the phase (tint) in the NTSC colour standard. The phase setting is stored until the instrument is switched off.

Pressing the **NTSC** key (F4) a second time to switch off the NTSC colour standard. The key is displayed as normal. PAL or SECAM transmissions can now be received again.

To leave the NTSC colour standard switched on, you have to press the **EXIT** key to exit this menu.

If the NTSC colour standard is enabled in the SAT range, **NTSC** appears in the upper right corner of the LCD in the default setting.

If switched off, the instrument is reset to PAL or SECAM reception in the SAT range.

## 5.6 LNB supply

Press the **LNB** key after selecting the SAT range.

The following menu appears in the function key row:

DiSEqC/UNI	14.0 V V	18.0 V V	22.0kHz LO	EXIT
------------	----------	----------	------------	------

Press a specific key to start that function.

After pressing the **14.0V V** key (F2), you can set the LNB supply voltage using the **STATION** ↓ and **SEARCH** ↑ keys. If the function is active, the key is displayed inverted. The LNB supply voltage can be adjusted in a range of 10V to 20V in 0.1V increments.

Similar to the first supply voltage, a second voltage can also be set between 10V and 20V by pressing the **18.0V H** key (F3).

To switch off the LNB voltage supply use **14.0V V** key (F2) or **18.0V H** key (F3) again.

Press the **EXIT** key (F5) to return to the standard frequency input mode.

A red LED on the RF input indicates that the remote voltage supply is on.

Once an LNB supply voltage is set, the inner conductor of the IEC socket is checked for short circuit or external voltage.

If a short circuit is found, the display shows the following:

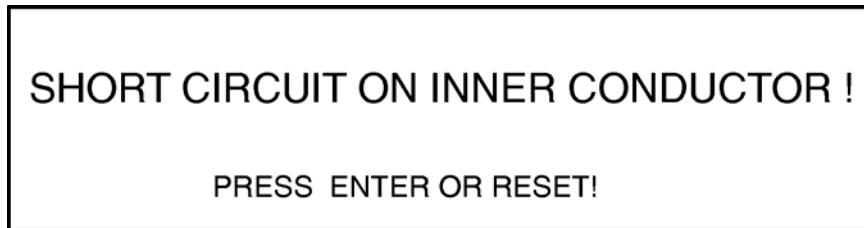

If an external voltage that is higher than the LNB supply voltage is present, the following is displayed:

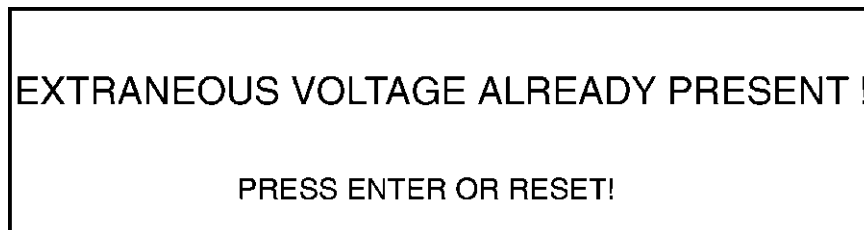

Press the **ENTER** key to keep the setting on the instrument and repeat the check.

### 5.7 **Output of signal frequency (22kHz)**

To drive the switchbox, the instrument can output a beat signal frequency of 22kHz via the test socket. This signal frequency is superimposed on the LNB supply voltage and can thus only be activated together with one of the two LNB supply voltages.

To output this signal frequency, first tune the instrument to a SAT frequency and start the measurement by pressing the **ENTER** key.

Afterwards press the **LNB** key and the following menu appears:

DiSEqC/UNI	14.0 V V	18.0 V V	22.0kHz LO	EXIT
------------	----------	----------	------------	------

After switching on the supply voltage, press the **22.0 kHz LO** key to enable the signal frequency. After activation, the signal frequency function key is displayed inverted and **LO** is changed to **HI**.

To switch off the signal frequency, press the **22.0 kHz HI** key (F4) again.

Press the **EXIT** key (F5) to return to the standard frequency input mode.

#### 5.7.1 *DiSEqC control (version 1.0, version 1.2 and version 2.0)*

**Introduction:**

DiSEqC defines a uniform and non-proprietary standard that is suppose to replace existing analog control systems in the long term. The switching commands are transmitted serially by 22 kHz tone pulses.

The following control routine is used in this instrument:

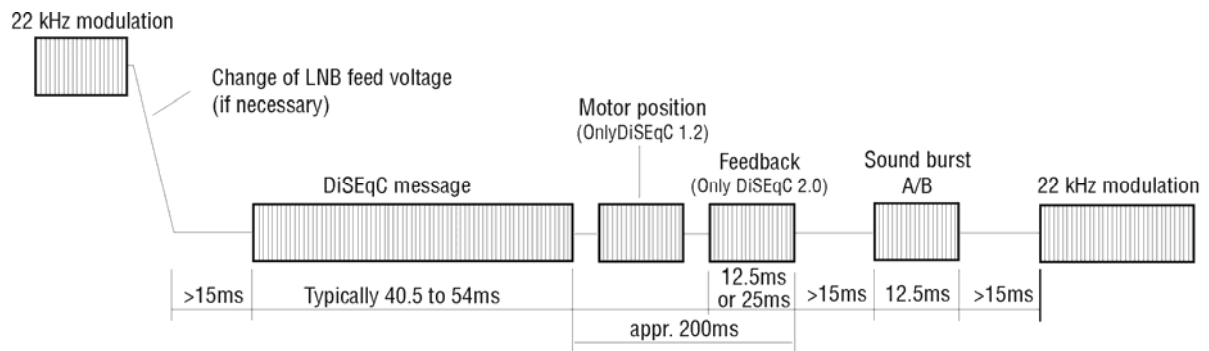

The 22kHz modulation, if present, is first switched off and the LNB supply voltage is set to the selected value. The DiSEqC message follows after a pause (The command for the motor position will be inserted for DiSEqC 1.2). With DiSEqC 2.0, a wait period of approx. 200ms is given for the return signal of the DiSEqC components. A sound burst is sent after about 20ms and, after an additional pause, the 22kHz modulation is switched on as well.

---

**Important!** ⚠ Only DiSEqC 2.0 components can give a return signal!

---

**Important!** ⚠ DiSEqC 1.2 is only required for positioners with a DiSEqC motor!  
DiSEqC 1.0 or DiSEqC 2.0 should be used in all other cases.

---

#### Use:

Press the **LNB** key after selecting the SAT range.

The following menu appears:

DiSEqC/UNI	14.0 V V	18.0 V V	22.0kHz LO	EXIT
------------	----------	----------	------------	------

If settings have already been entered, the corresponding function keys appear inverted.

Press the **DiSEqC/UNI** key (F1) to open a submenu.

DiSEqC 1.0	DiSEqC 1.2	DiSEqC 2.0	DiSEqC off	UNICABLE
------------	------------	------------	------------	----------

The DiSEqC version is chosen and activated with the function keys **DiSEqC 1.0** (F1), **DiSEqC 1.2** (F2) and **DiSEqC 2.0** (F3). After pressing one of the three keys, the previous menu is shown again and the function key (F1) indicates the selected DiSEqC version (e.g. **DIS1.0 P1**). This means DiSEqC version 1.0 and satellite position 1. If DiSEqC 1.2 or DiSEqC 2.0 has already been activated (function key is displayed inverted) and is pressed again, a submenu will be opened (see the chapter on additional settings for DiSEqC).

Upon activation, the complete DiSEqC information (satellite position, polarisation, low-band or high-band) is given out.

Possible satellite positions can be selected using the numeric keypad (positions 1 to 4 for DiSEqC 1.0 and positions 0 to 99 for DiSEqC 1.2. Position 0 is the reference position 0 degrees). The complete DiSEqC message is output each time a key is pressed.

The same command can be given again and again by repeated selection of the same button (cascadable).

With DiSEqC 1.2, the **Fine** ← and **Tune** → keys can be used at this point to move the DiSEqC motor gradually to the east or west. The motor moves in the selected direction until the key is released. The direction is displayed in brackets. The level is constantly updated while the motor is moving (also in analyzer).

The following table shows the according DiSEqC functions of each satellite position:

Satellite position	DiSEqC function		Sound burst
	"Satellite position"	"Option"	
P1	A	A	A
P2	B	A	B
P3	A	B	A
P4	B	B	B

Further DiSEqC functions can be selected with the mentioned menu items as follows.

Menu item	DiSEqC function
"1= 14.0V V"	Vertical polarisation
"2= 18.0V H"	Horizontal polarisation
"3= 22.0k LO"	Low band / High band

The feed voltage or modulation frequency plus the complete DiSEqC message is output by pressing one of these three function keys. Once a function key is activated, you see it inverted. In the case of key F4 **22.0 kHz LO** the letters **LO** also change to **HI**, in other words the high band is selected.

By pressing the function key F1 anew (e.g. **DIS1.0 P1**), returns to the branched sub-menu.

DiSEqC 1.0	DiSEqC 1.2	DiSEqC 2.0	DiSEqC off	UNICABLE
------------	------------	------------	------------	----------

The DiSEqC function can be switched off again with the function key **DiSEqC off** (F4). You can return to the LBN menu with the function keys **LNB** or **ENTER**.

### 5.7.1.1 Additional settings for DiSEqC 1.2

If the inverted **DiSEqC 1.2** function key (F2) in the submenu is pressed again, a second submenu is opened.

F1(SAVE) = Save satellite position speichern F2(LIMITS) = Set and reset limits F3(RE-CALCUL.) = Move satellite positions				
SAVE	LIMITS	RE-CALCUL.		EXIT

The **SAVE** (F1) key stores the current position of the satellite dish in the DiSEqC motor to a satellite position number that must be entered.

The **LIMITS** (F2) function key can set and reset the software limits of the DiSEqC motor. The current position of the DiSEqC motors is accepted as a limit.

The **RE-CALCUL.** (F3) key changes all stored satellite positions in the DiSEqC motor to a defined offset (see DiSEqC motor operating manual).

The **EXIT** (F5) key returns to the LNB menu.

### 5.7.1.2 Additional settings for DiSEqC 2.0

If the inverted **DiSEqC 2.0** function key (F3) in the submenu is pressed again, a second submenu is opened.

STATE	STATUS		MANUAL	EXIT
-------	--------	--	--------	------



Press the **STATE** key (F1) to determine and display the switching state of the components. The **E2 10 14** DiSEqC message is used for this.

Example:

OPTION SWITCH: NOT AVAILABLE SATELLITE POSITION: A POLARIZATION: VERTICAL LOW/HIGH BAND: LOW				
STATE	STATUS		MANUAL	EXIT

Press the **STATUS** key (F2) to determine and display the status of the components. The **E2 10 10** DiSEqC message is used for this.

Example:

BUS-COLLISION BIT: NOT SET STANDBY MODE: NOT SELECTED EXTERN POWR SUPPL.: NOT AVAILABLE REMOTE FEED VTG >15V: NO RESET FLAG: SET				
STATE	STATUS		MANUAL	EXIT

Both the **EXTERN POWER SUPPL.** and **REMOTE POWER SUPPL. > 15V** messages are only valid if supported by the DiSEqC 2.0 components.

The **MANUAL** key (F4) allows you to manually enter the component addresses and commands. The E2 start byte is preset.

The following text appears:

DiSEqC 2.0 INQUIRY: E2 ... ..				
STATE	STATUS		MANUAL	EXIT

The address and then the command can now be entered via the numeric keypad. The query automatically starts after the 4th digit is entered. The return signal is displayed on another line.

Example:

DiSEqC 2.0 INQUIRY: E2 10 14 REPLAY: E4 07				
STATE	STATUS		MANUAL	EXIT

For more information on the commands and messages, refer to the "DiSEqC Commands Table" chapter.

- In our example:
- E2** Command with return signal (start byte)
  - 10** Address group for all switching components
  - 14** Readout of current switching status (command)
  
  - E4** Ok, no error
  - 07** Bit pattern of switching status byte

Press the **MANUAL** key (F4) again to start another DiSEqC 2.0 query.

---

**Important!**  The switching status of the DiSEqC components can also be changed with the **MANUAL** function. This means the switching status stored in the instrument no longer matches the current switching status of the components. Returning to the LNB menu with the **EXIT** key (F5) and then requesting the same satellite position allows you to transmit the instrument's switching status to the components and set them accordingly.

---

**Important!**  If the DiSEqC control is activated, the LNB supply voltage switches through simultaneously. The DiSEqC components work with a supply voltage of 12V to a maximum of 20V. This allows you to work with the 14V/18V switching criteria at the same time as well.

---

**Note!**  The leading load on the antenna cable must not exceed 250nF. (DiSEqC specification)

---

Press the **EXIT** key (F5) in the LNB menu to return to the standard frequency input mode.

The settings selected through the DiSEqC control now appear at the top of the display.

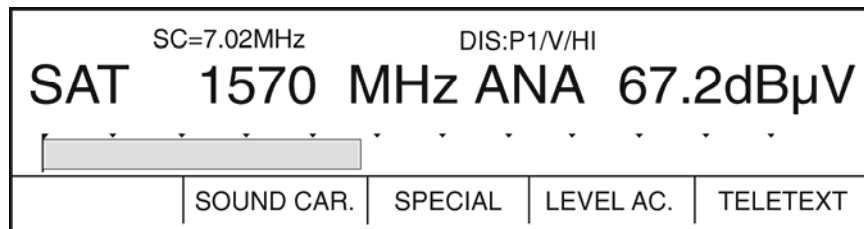

**Definitions:**

- |           |                                     |
|-----------|-------------------------------------|
| DIS or DI | DiSEqC is activated                 |
| P1 to P99 | Satellite position 1 to 99          |
| V or H    | Vertical or horizontal polarisation |
| LO or HI  | Low band or high band               |

The **OK** designation appears in place of **DIS** in DiSEqC 2.0. This means that DiSEqC 2.0 components have sent an OK back. If an error occurs, the relevant error message is indicated (eg, **NOT RESPONDING**).

The settings of the DiSEqC control are stored just like the 14V/18V switching criteria and 22kHz modulation. The satellite is also stored.

---

**Important!**  If the instrument is switched off and back on again while the DiSEqC control is active, the DiSEqC control remains active (default setting is DiSEqC 1.0 or DiSEqC 1.2). The DiSEqC control can only be switched off by pressing the **DiSEqC OFF** key (F4) in the submenu.

---

### 5.7.2 UNICABLE System

**Introduction:**

The version "UNICABLE" (signal distribution from satellite signals over a single coaxial cable distribution network) is a variant of the Diseq control, which corresponds to the DIN EN 50494 standard. With this system, the desired transponder is set to a fixed frequency (centre frequency of the UB slot or band-pass) in the UNICABLE unit (LBN or multi-switch).

The information co-ordinating transponders and UB slots is transmitted via the special DiSEqC command to the UNICABLE unit. The standard supports up to 8 UB slots. This allows up to 8 receivers to be operated on 1 cable.

The UNICABLE message contains the following information:  
 The SCR address, horizontal and vertical polarisation, low or high band, and the transponder frequency to be set.

The following control routine is used in this device:

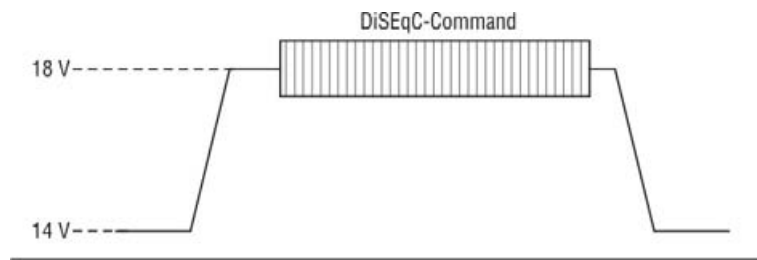

With UNICABLE systems, the transmitting receiver generates a high DC level as it transmits, to which is added to the UNICABLE message (special DiSEqC command). After transmitting the UNICABLE message, the receiver returns to an idle state, in which a low DC level is generated. The receiver must return to a low DC level, so that the system is available for other receivers.

The limits for the low DC level are: 12.5 V to 14 V  
The limits for the high DC levels are: 17 V to 19 V

The measuring receiver takes the voltage that is displayed in the F2 key (e.g. 14.0 V) as the low DC level, and the voltage that is displayed in the F3 key (e.g. 18.0 V) for the high DC level. Both of these values can be changed, as with the DiSEqC control.

**Use:**

Press the **LNB** key after selecting the SAT range.

The following menu appears:

DiSEqC/UNI	14.0 V V	18.0 V V	22.0kHz LO	EXIT
------------	----------	----------	------------	------

If settings have already been entered, the corresponding function keys appear inverted.

If the UNICABLE control has already been activated, the F1 key **UNICABLE P1** is inverted. With UNICABLE control activated, the F1 key can be used to skip the next sub-menu and the SCR address and the UB frequency can be set immediately. In addition, the **UNICAB off** key (F4) can be used to switch off the UNICABLE control.

Press the **DiSEqC/UNI** key (F1) to branch to a submenu.

DiSEqC 1.0	DiSEqC 1.2	DiSEqC 2.0	DiSEqC off	UNICABLE
------------	------------	------------	------------	----------

The **UNICABLE** key (F5) is used to select and activate the UNICABLE version.

Pressing this key will display the following menu

SCR-ADR: 1 UB-FREQ:1516MHz				
Standard-RF: LOF 9750/10600MHz				
SCR-Adr.	UB-FREQU.	Brdbd. RF	UNICAB off	EXIT

The SCR address (Satellite Channel Router), the corresponding centre frequency of the UB slot (user bank bandpass) and the mode (standard or broadband RF) can be set here. For the relevant data refer to data sheet of the UNICABLE unit (LNB or multi-switch).

---

**Important!**  The SCR address must be entered – not the receiver number.

---

If the **SCR-Adr.** key is displayed inverted, an address between 0 and 7 can be entered using the numeric keypad.

The centre frequency of the UB slot corresponding to the selected address is displayed. If the UB frequency (in accordance with the UNICABLE unit data sheet) does not correspond to the displayed SCR address, the UB frequency must be re-entered.

For this, press the **UB-FREQU** key (F2) to enter the correct UB frequency.

Use the **ENTER** key to complete the entry.

After each change of SCR address and/or UB frequency, the complete UNICABLE message is transmitted, as long as the measuring receiver had been tuned to a transponder frequency.

Press the **Brdbd. RF** function key (F3) to switch to broadband RF mode. This is a special mode used by some UNICABLE units. Only a local oscillation frequency is used here. This means that the LOW band and the HIGH band are combined into a single one band.

If the **Brdbd. RF** function key (F3) is pressed, it is displayed inverted and the following message appears on the display: Broadband RF: LOF 10.200 MHz.

The standard provides 4 possible local oscillation frequencies (10,000MHz, 10,200MHz, 13,250MHz and 13,450MHz). Press the **FINE** ← or **TUNE** ← keys to select one of the 4 local oscillation frequencies (in accordance with the UNICABLE unit data sheet).

Press the **Brdbd. RF** function key (F3) again to switch from broadband mode back to standard mode. In standard mode, the local oscillation frequency of 9,750MHz is used for the LOW band and 10,600MHz for the HIGH band.

The instrument also resets to standard mode after the UNICABLE function is switched off.

In broadband mode, it is useful to operate the instrument in transponder frequency mode (RF autom.) since one can enter the entire frequency range from 10,700MHz to 12,750MHz.

Press the **EXIT** key (F5) and the previous menu will be displayed again.



The F1 key now displays the selected UNICABLE version (e.g. **UNICAB P1**). This means UNICABLE version and satellite position 1.

Use the numeric keypad to select the 2 possible satellite positions (1 and 2).

The (F2), (F3) und (F4) keys, as with the DiSEqC control, are used to select the vertical or horizontal polarisation and the low or high band.

With each press of these keys, the complete UICABLE message is transmitted, as long as the measuring receiver had been tuned to a transponder frequency.

Therefore, repeated pressing of the same key, e.g. satellite position 1, results in the repeated transmission of the same UNICABLE message. This can be necessary, if on one cable several receivers transmit a message at the same time. If there is a collision of UNICABLE messages in the cable, the UNICABLE unit cannot evaluate the message. Therefore the message must be repeated.

Pressing the **EXIT** key (F5) returns to the frequency input mode.

If the same frequency is entered again, the same UNICABLE message is again transmitted.

The settings selected with the UNICABLE control appear at the top of the display when the transponder is recalled.

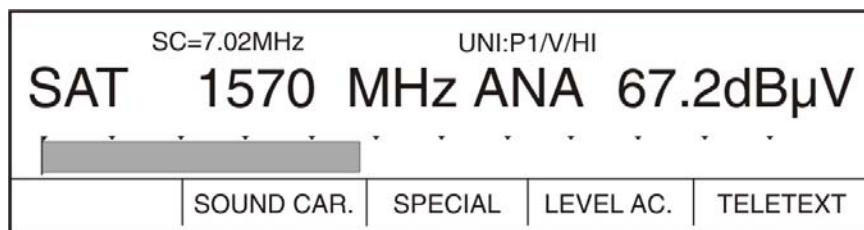

**Definitions:**

- UNI                                 UNICABLE is activated
- P1 and P2                         Satellite position 1 and 2
- V or H                             Vertical or horizontal polarisation
- LO, HI or WI                     Low band, high band or wide band (at broadband RF)

The settings from the UNICABLE control are also stored in the tuning memory.

---

**Important!**  The UNICABLE control is always deactivated when the instrument is turned on. The UNICABLE control can be switched off manually using the **UNICAB off** key (F4) in the sub-menu. This also switches broadband mode back to standard mode.

---

## 5.8 Sound carrier selection

It is possible to tune the sound carrier frequency in the range of 5MHz to 9.75MHz in 10kHz increments and assess the demodulated AF signal via the integrated loudspeaker or a pair of headphones.

Press the **SOUND CARRIER** key to do so. The function key appears inverted after it has been activated (an intermediate menu is displayed for instruments with an ADR decoder – see "ADR Decoder" chapter). Angle brackets around the sound carrier frequency (>... MHz<) also indicate that you can select the carrier.

Use the **FINE** ← and **TUNE** → keys to change the sound carrier. A new sound carrier frequency can also be entered directly via the numeric keypad. Press **ENTER** to confirm your entry.

Press the **SOUND CARRIER** (F2) or **EXIT** (F5) keys after changing the sound carrier. The **FINE** ← and **TUNE** → keys can still be used to adjust the frequency.

## 5.9 Relative measurement (C/N measurement)

The **special program 88** allows you to measure the difference from a reference level.

First specify a channel or frequency on the instrument and initiate the measurement. You can now access the special program by pressing the **MODE** key and entering the digits **88**.

The following is displayed briefly:

RELATIVE MEASURM. (C/N): ON

The display shows the previous operating status again. The level value is set to **0** and from now on shows the difference from the absolute value of the measurement. The **RELATIVE** message in the top line indicates the operating status.

The relative value appears with a **+** or **-** sign.

This allows you to identify the value in relation to the reference level.

This function can be disabled by accessing the **special program 88** again. The level indicator now shows the absolute value of the measurement again.

This special program can also be used in conjunction with other programs and functions for the instrument such as the acoustic level trend indicator, measuring resolution switch and dB display level switch.

**C/N measurement:** When determining the quality of a satellite system, use the **C/N value** instead of the absolute value of a measured level. The C/N value is the ratio between the carrier and the background noise of the system. Displaying the C/N value in the satellite range is possible using the **special program 88**.

This instrument allows you to display the C/N value of the measured satellite transponder.

To determine this value, tune the instrument to an occupied frequency in the satellite range and point the antenna towards the satellite.

To determine the background noise, the antenna must be moved upwards in order to receive a satellite signal.

Now access the special program by pressing the **MODE** key and entering the digits **88**.

The background noise is now the reference level. The C/N value is displayed once the antenna returns to its optimal reception position.

This special program can also be used in conjunction with other programs and functions for the instrument such as the acoustic level trend indicator, measuring resolution switch and dB display level switch.

### 5.10 S/N measurement, C/N measurement (optional)

An instrument equipped with the optional S/N measurement **directly** measures the S/N value of the analog television range (VHF, VHF-S and UHF) and the C/N value of the analog SAT range and displays the result in the upper right corner.

The measurement resolution corresponds to the resolution of the level measurement (0.1dB or 1dB).

---

**Important!**  The dB indicator level (MODE 84) must be set to normal for the S/N value to be visible and printable.

---

Display example:

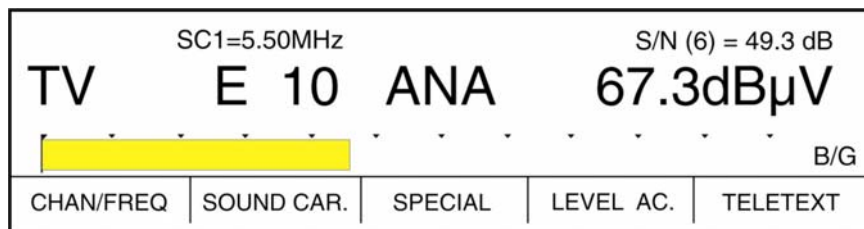

The figure in brackets after S/N indicate which line is being analysed. **Special program 89** allows you to select lines 5, 6 or 7.

Line 6 is used in most cases and contains no picture information. There are however TV stations that transmit information on line 6. Switch over to line 5 or 7 if this is the case.

In the SAT range make sure the correct video deviation setting is selected.

The default setting is 16MHz/V and is used by most of the transponders.

If a transponder sends a video deviation of 25MHz/V, then the video level would be too high. The **V. 25MHz/V** key (F1) allows you to switch over to a deviation of 25MHz/V while maintaining the video level at 1V<sub>SS</sub>, which is necessary for C/N measurement.

The S/N display is disabled for teletext and digital modes.

### 5.11 Television return channel range

You can also feed in a return channel signal via the RF input on the front panel. The frequency range is 5 - 65MHz and can be changed in 50kHz increments.

The measuring bandwidth is set to 200kHz (delivery before April 2006: 1 MHz).

The return channel signal is processed like an analog television signal. The fed-in return channel signal is visible on the screen as a television picture.

### 5.12 Television IF range

You can also feed in a television IF signal via the RF input on the front of the instrument. The frequency range is 5 - 47MHz and can be changed in 50kHz increments.

Press the **RANGE** key to access the menu for IF measurement.

The result appears in the display as a corrected final value in dBµV.



To display the teletext of the IF signal, press the **TELETEXT** key (F5). Refer to the **chapter on TELETEXT** for additional teletext functions.

Press the **SPECIAL** key (F3) to fade in the vertical blanking interval. An extra row in the menu will appear. Now you can press the **BLANKING** key (F3) to activate this function. If the function is active, the corresponding key is displayed inverted.

### 5.13 Frequency detuning

The **FINE ←** and **TUNE →** keys allow you to change the preselected frequency in small increments. Changes are shown in the display. The step rate increases the longer the key is pushed.

The change in level can be seen on the bar graph in the display.

You can also notice the change over the loudspeaker if the acoustic trend indicator is switched on.

Fractional detuning allows you to detect possible misalignments from community antenna installations, modulators or LNB's.

In the broadcasting range, the detuning keys change the incoming frequency in increments of 10kHz.

In the TV range, the frequency can be detuned in 50kHz increments.

If you tuned to the station in channel mode, the channel indicator becomes a frequency indicator after pressing one of the detuning keys. Press and hold a key down for a moment to see the current frequency in the display. If the incoming frequency is outside the channel grid due to fractional detuning, the display does not return to the channel mode since a specific channel can no longer be assigned.

The display automatically switches back to the channel display after an extended period in which no entry is made or when a key other than the detuning keys is pressed.

If you switch to channel mode after entering a frequency outside the channel grid, the instrument remains in frequency mode.

In the SAT range you can switch the detuning resolution using the **special program 72**. Access this program to switch between 125kHz and 1MHz increments.

### 5.14 Station search

Start the search by pressing the **STATION ↓** and **SEARCH ↑** keys (not with UNICABLE).

Preset the desired range and stations with sufficient field strength can be searched for automatically.

Briefly press a key to switch the TV range to the adjacent channel - regardless of the existing station.

Hold down the **SEARCH ↑** key for moment and the search begins at the lower range end until the first station with sufficient field strength is found.

Press the **STATION ↓** key to begin the search at the upper range end.

If no station is found before the end of the range, the search will start again from the other end.

If you specify a frequency and press one of the search keys, the search starts from that frequency towards higher (**↑**) or lower (**↓**) frequencies.

Hold the **STATION ↓** or **SEARCH ↑** keys down to search the range without stopping. Release the key and the search automatically continues until the next station with a sufficient level is found.

The stop limit of the search is 35 dB $\mu$ V in the radio broadcasting range, 35 dB $\mu$ V in the TV range, and 42 dB $\mu$ V in the SAT range. When one of these values is exceeded, the search stops and the picture is displayed.

If the level of the station is below this value (or is not an analog station), the search automatically continues.

The search can be stopped at any time by pressing and holding down **ENTER**.

### 5.15 Blanking interval

You can determine the level of reflection even while a program is running by fading in the blanking interval on the screen.

To do so, press the **SPECIAL** key (F3) in television, satellite or monitor mode.

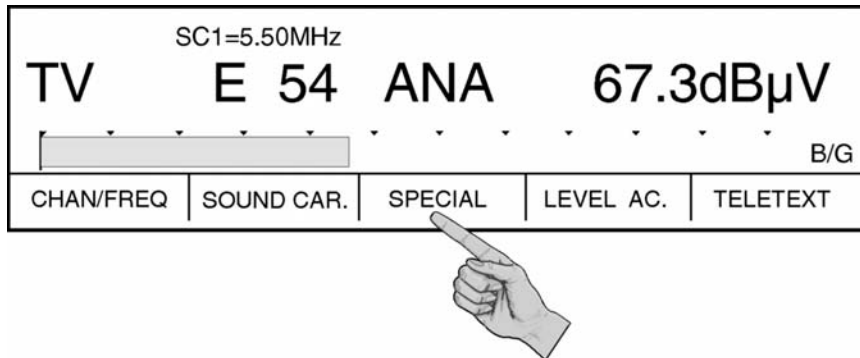

Now press the **BLANKING** key (F3).

**Important!** If the **SCOPE** option is installed, the **blanking interval** function is disabled.

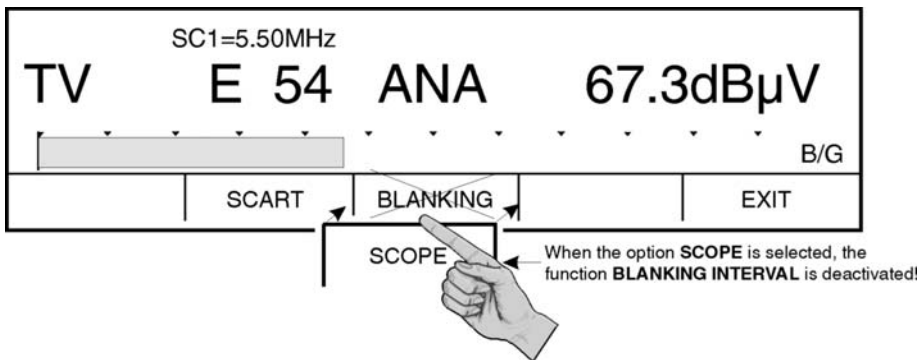

The blanking interval and black and white picture are now visible.

If activated, the **BLANKING** key is displayed inverted. To switch off the blanking interval, press the **BLANKING** key (F3) again.

Press the **EXIT** key (F5) to return to the main menu.

Press a different range key or **RESET** to switch off the blanking interval function.

### 5.16 SCOPE (optional)

#### 5.16.1 Introduction

The **SCOPE** option provides an oscillographic representation of television lines in real time. A variety of transmission parameters can be visually recorded using the test line signals that are fed into the range of vertical blanking intervals (per CCIR 473-3). These include hum, reflections, group delay distortions, non-linearity and frequency response errors. Depending on the circumstance, different test lines are required to display these parameters. The main test lines are 17, 18, 330, 331. Not all test lines are provided by all stations.

In combination with S/N measurement, you can check whether the line (6) being used for measurement is actually empty. If necessary, you can switch to either line 5 or 7.

The residual carrier can also indirectly be determined in the TV range. A residual carrier value of 11% (standard) results in a video signal amplitude of 100% (blanking value – white value). There are transponders in which the residual carrier is larger and thus the video amplitude is smaller.

In the SAT range, a frequency deviation of 16MHz/V results in a video amplitude of 100%. If a video deviation of 25MHz/V is present, the video amplitude increases.

This can, however, be compensated for by switching the video deviation setting (see 5.4.2).



100% video amplitude is provided at the SCART socket (1V<sub>PP</sub> at 75 Ohm). 0% is available for the blanking value, 30% for the black level and 100% for the white value. The SCOPE option offers another useful function to determine an amplitude hum in cable systems. A defective amplifier can cause low frequency (mains frequency) amplitude fluctuations resulting from a faulty power supply unit.

This can lead to a video hum with BB signals. If large enough, it causes a continuous bar to appear on the screen.

Turn on the hum measurement function and the black value (30%) is scanned and traced once on each line in the picture. This makes the envelope curve of the hum visible before a fault is visible on the screen.

### 5.16.2 Selecting the SCOPE function

The **SCOPE** function is available in television, satellite or monitor mode.

**Important!** ⚠ If the **SCOPE** option is installed, the **blanking interval** function is disabled.

To activate the function, first press the **SPECIAL** key (F3).

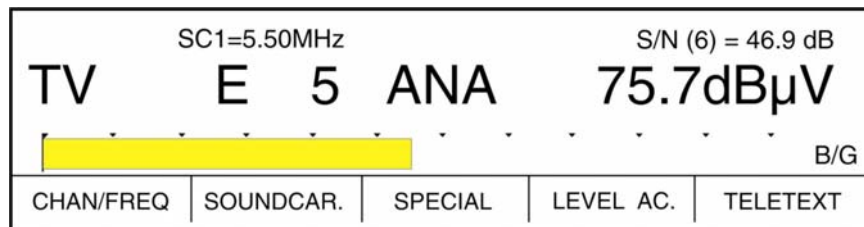

Now press the **SCOPE** key (F3).

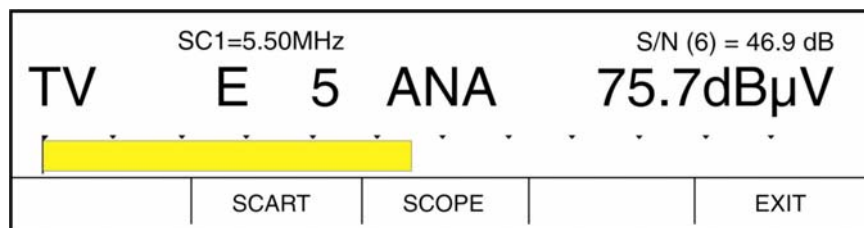

The instrument switches to the graphic mode and displays the default line 17. The line is displayed in real time.

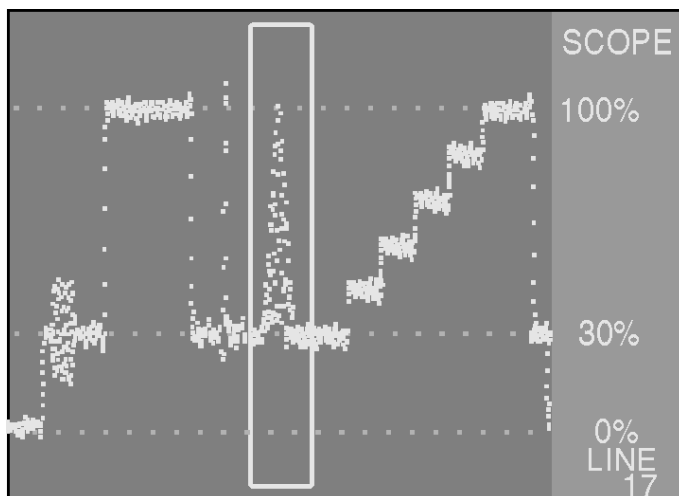

### 5.16.3 Selecting a line

The selected line number appears in the right margin of the diagram.

A line between 1 and 625 can be entered using the numeric keypad.

The number appears with a red background during entry. Press **ENTER** to confirm the entry.

### 5.16.4 Freezing the oscillogram

You can freeze the oscillogram by pressing **STOP** (F1). Press the key again to resume.

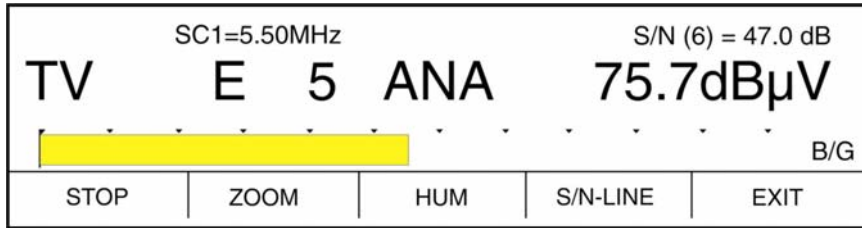

### 5.16.5 Zoom function

The oscillogram can be expanded using this function. Press **ZOOM** (F2) to enlarge the diagram section in the zoom window to the full width of the screen. Press the key again to return to the normal window size. Press **ENTER** to hide or reveal the zoom window.

The window can also be made larger or smaller using the **STATION** ↓ and **SEARCH** ↑ keys. 3 sizes are available. You can also move the oscillogram left or right with the **FINE** ← and **TUNE** → keys. This allows you to zoom in on any section of a line.

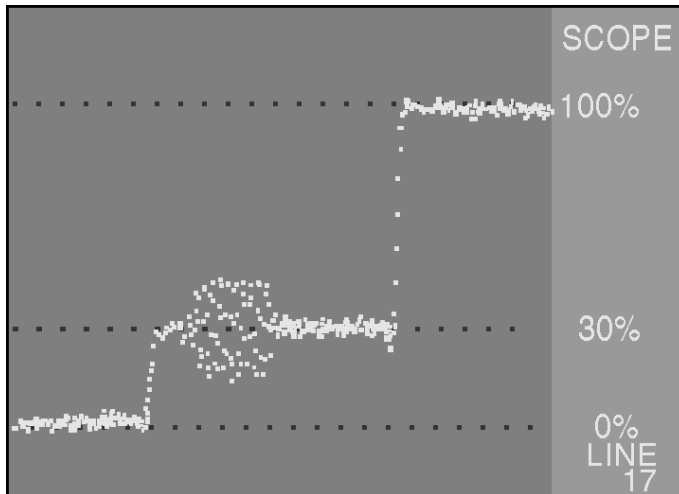

### 5.16.6 Hum measurement

Press **HUM** (F3) to activate this function. Press the key again to return to the oscillogram.

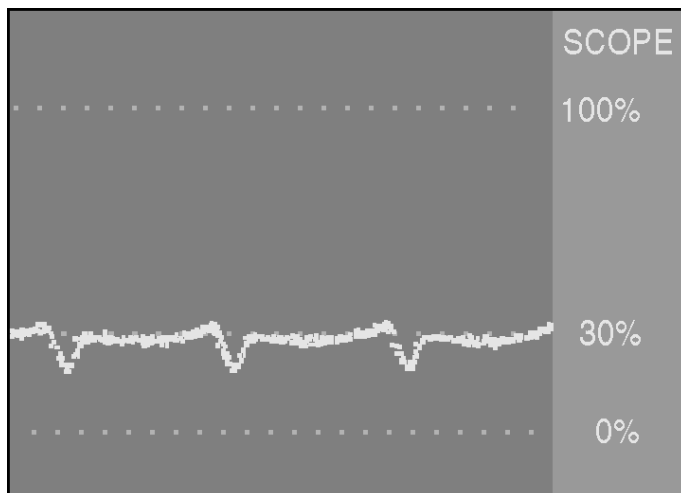

### 5.16.7 Selecting the S/N line

The line to be used for S/N measurement can be set with the **S/N-LINE** key (F4). Press this key to receive a menu in which you can select line 5, 6 or 7. The selected line appears in the display – eg, S/N (5) = 47.6dB.

## Chapter 6

### Teletext

---

After tuning to a station, you can activate the teletext from that station by pressing **TELETEXT** (F5).

Teletext is available for both television and satellite stations, but not for digital channels.

**PAGE 100** of the teletext from the station appears.

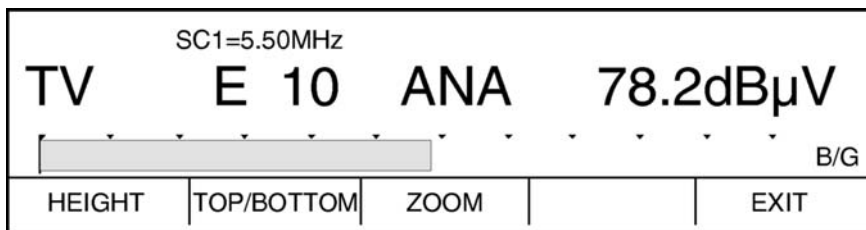

Use the numeric keypad to enter a specific page number.

To magnify the contents of a teletext page, press **HEIGHT** (F1). This magnifies half of the page. The **TOP/BOTTOM** key (F2) allows you to switch to the top or bottom half of the screen. To view the entire contents of a teletext page, press **HEIGHT** (F1) again.

The **ZOOM** key (F3) expands the picture downwards about 12% for better resolution.

Press **EXIT** (F5) to leave the teletext mode.

## Chapter 7

### Measurements in the digital range

---

#### 7.1 Selecting the range

Press **RANGE** to receive the following display:

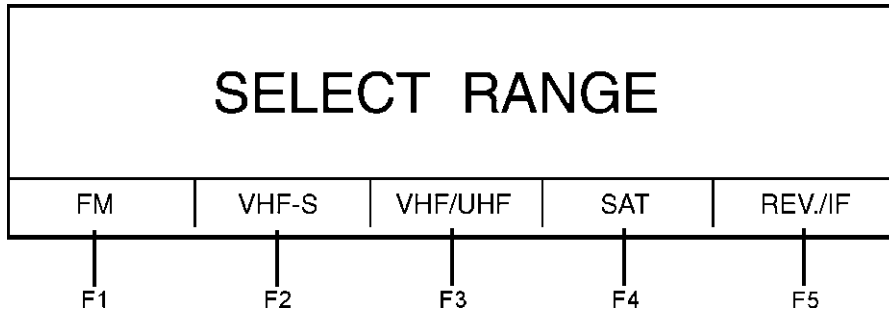

Use the function keys (F1-F5) to select a specific range. Digital measurements can be performed in the SAT (QPSK) range and the VHF-S or VHF/UHF (QAM, COFDM) range. Switch the instrument's mode to digital (DIG) with the ANA/DIG key.

#### 7.2 Remote supply

See the section on remote supply in the chapter "Analog level measurement and video check".

#### 7.3 DVB-S (QPSK)

QPSK (Quadrature Phase Shift Keying) is a digital modulation process that enables digital audio and video signals to be transmitted via satellite (DVB-S). The carrier frequency is divided into four different phase states. The FEC (Forward Error Correction) has internal and external error protection (the Viterbi and Reed Solomon decoder, respectively). These decoders can, to a certain limit, remove bit errors caused by various effects in the transmission channel. The test receiver uses this error correction mechanism to determine the bit error rate.

In the SAT range, the receiver is set to QPSK (DVB-S).

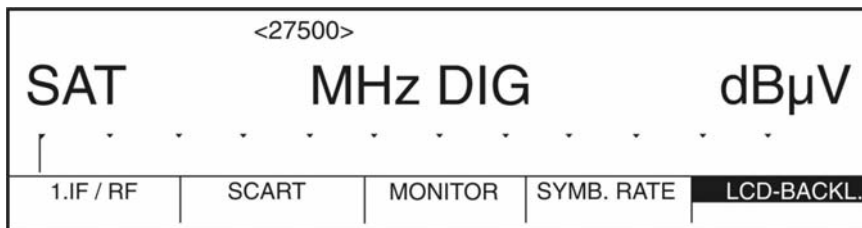

A frequency in the 1. SAT-IF range can now be entered. Press **ENTER** to initiate the measurement.

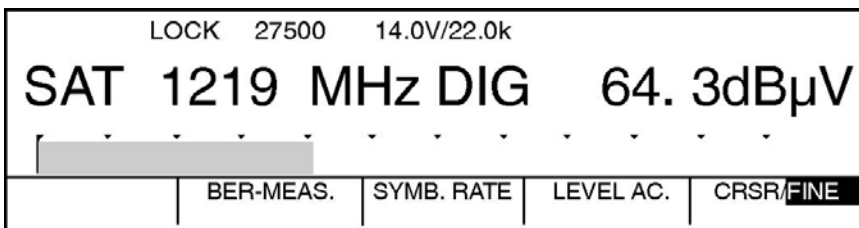

If a QPSK-modulated signal is present, the instrument responds with **LOCK** in the display, otherwise **UNLOCK** appears. If the instrument shows **UNLOCK**, the set symbol rate should be checked first. The symbol rate for the signal to be measured must be known and the set accordingly on the receiver.

### 7.3.1 Changing the symbol rate

The symbol rate of the receiver must be set in the 2 - 30Msym/s range (delivery later April 2004: 2 – 45 Msym/s). This allows SCPC (single channel per carrier) transmissions to be measured as well.

Enter the symbol rate as follows:

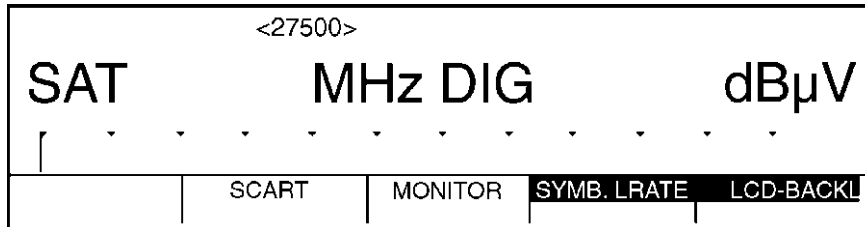

Press the **SYMBOLRATE** key (F4). The symbol rate in kSym/s (kBd) can now be entered via the numeric keypad. Press **ENTER** to confirm the entry.

### 7.3.2 Level measurement

The level of the incoming QPSK signal can be measured as soon as the **LOCK** message appears in the display. The bar graph makes it easy to follow changes in the level.

The acoustic level trend indicator can also be turned on if necessary.

Where as the peak value is found when measuring the level of the analog video carrier, the receiver measures the mean noise power in the QPSK signals. The average noise power is measured in the middle of the carrier at 8 MHz, 4.3 MHz or 1 MHz bandwidth (depending on the symbol rate) and is corrected for bandwidth.

### 7.3.3 Searching, frequency detuning

How the arrow keys function can be determined with the **CURS/FINE** key (F5).

If set to **CURS**, the arrow keys can be used to control the MPEG-2 decoder (see "MPEG Decoder" chapter). Otherwise the **FINE-TUNE** keys are used to detune the receiver in the 1MHz or 125kHz grid (refer to special program 72).

Start a search by pressing the **STATION** ↓ **SEARCH** ↑ keys (not with UNICABLE). The receiver then searches the SAT range for QPSK-modulated signals in both positive and negative directions with the currently selected frequency and symbol rate as the starting point. The 27500kB and 22000kB symbol rates are also tested. The receiver ends the search when a signal with the set symbol rate is found.

If a frequency has not yet been tuned, then the search starts from the lowest or highest SAT frequency.

The search can be stopped at any time by pressing and holding down **ENTER**.

### 7.3.4 Assessing the picture and sound

The QPSK receiver module (QPSK FRONT END) supplies the transport stream. It can contain several video and audio programs or only data-based services. To reproduce the programs, the transport stream must be analysed and decoded.

This is done with the MPEG-2 decoder. For more information on using the MPEG-2 decoder, see the "MPEG Decoder" chapter.

### 7.3.5 Measuring the bit error rate (CBER or VBER)

Press **BER-MEAS.** (F2) to access the bit error measurement menu.

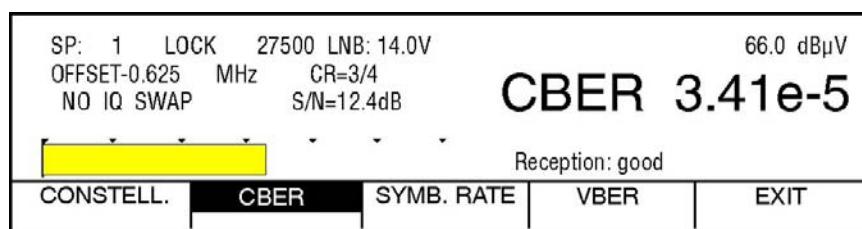

The bit error rate **before Viterbi** (CBER), the bit error rate before Reed-Solomon (VBER), the level, the carrier frequency offset, the code rate, a possible spectrum inversion and the S/N value are displayed.

Use the CBER and VBER keys to select the bit error rate **before Viterbi** (CBER – Channel Bit Error Rate) or **before Reed-Solomon** (VBER - Viterbi Bit Error Rate).

The bit error rate is indicated in three ways. It is represented as a number with exponential notation, a bar graph in logarithmic format and as a qualitative assessment. The qualitative assessment comprises the following categories:

Bit error rate	Reception quality
<1.00e-6	good
1.00e-6<BER<1.00e-3	conditional
>1.00e-3	poor

**Note!**  The bit error rate before Reed Solomon (VBER) is always used for the qualitative assessment.

The error correction method implemented in the Viterbi decoder is used to measure the CBER. The bit current is compared before and after the decoder and deviating bits are summed up with a bit error counter.

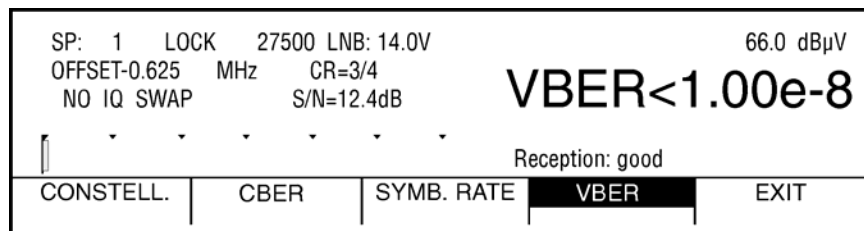

The error correction method implemented in the Reed-Solomon decoder is used to measure the VBER. At this point, the bit error rate can be measured in the receiver with all 3 DVB reception modules (DVB-S, DVB-C and DVB-T) in the same way. The following conclusion can therefore be made for all three reception types.

The signal can be considered error free if the bit error rate is 2.00e-4 (quasi error free, QEF), since statistically speaking only one non-correctable error occurs per hour.

However, even slight signal deterioration can cause complete reception failure.

If the bit error rate is VBER 5.00e-8, for example, then 5 defective bits are received out of 100 million. The measuring time for the bit error rate depends on the symbol rate. As an example, a symbol rate of 27500kBd results in a measuring time of about 2 seconds.

### 7.3.6 Measuring the carrier frequency offset

The QPSK-FRONT-END can demodulate QPSK signals as long as the difference between the transmitted and incoming frequencies is less than 12.5% of the symbol rate. The frequency difference is displayed in MHz with a plus or minus sign. A positive value means the incoming frequency is higher than the transmitting frequency. Measuring the frequency deviation can be used to test the accuracy of the LNB frequency.

### 7.3.7 Measuring the IQ phase position

**IQ SWAP** and **NO IQ SWAP** indicate whether the incoming QPSK signal is in the default position (NO IQ SWAP) or the inverted position (IQ SWAP).

A signal can be rearranged to move it from the default position to the inverted position.

### 7.3.8 Measuring the signal to noise ratio (S/N) in the baseband

The S/N ratio is measured in the baseband directly after the demodulator. The measuring range is 2-15dB. If noise is the only interference factor, which is usually the case with satellite transmission, then the S/N ratio is identical to the modulation error rate (MER). If the symbol rate is used as noise bandwidth, the carrier noise ratio (C/N) in the SAT-IF range is similar to the S/N ratio in the baseband.

A bit error rate of approx.  $2.00e-4$  before the Reed-Solomon decoder is required for a virtually error-free QPSK signal. At this signal quality the S/N value is approx. 7.3dB with a code rate of 3/4. The S/N value can provide information about the system reserve. If the measuring instrument indicates an S/N of 10.2dB, for example, then the system has a reserve of 2.9dB. The C/N can therefore deteriorate by 2.9dB (due to bad weather perhaps) without it becoming noticeable in the picture and sound played back through the MPEG-2 decoder. For this reason always set the S/N value to the maximum when adjusting a parabolic antenna. The S/N value is also directly related to the bit error rate before Viterbi. This cannot be measured by the instrument.

7.3.9 Constellation diagram (QPSK)

Press **CONSTELL.** (F1) to access a display of the constellation diagram (see "Constellation Diagram" chapter).

7.4 DVB-S2 (QPSK, 8PSK), DVB-S1 (QPSK) (with optional DVB-S2 card only)

DVB-S2 is a new standard in satellite transmission.

DVB-S1 corresponds to the old DVB-S standard.

A higher data rate can be transmitted using the same bandwidth with the new DVB-S2 standard.

The following is displayed if the SAT range is selected.

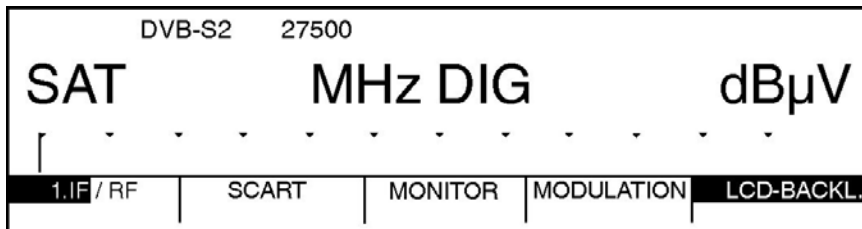

The standard set on the measuring receiver (DVB-S1 or DVB-S2) is displayed at the top left. Press the **MODULATION** function key (F4) to open a submenu which allows you to change the standard. The symbol rate can also be changed.

**Important!** The standard set must be the same as the standard received!

Measurement is started after you enter a frequency in the range of the 1<sup>st</sup> SAT-IF and press **ENTER**.

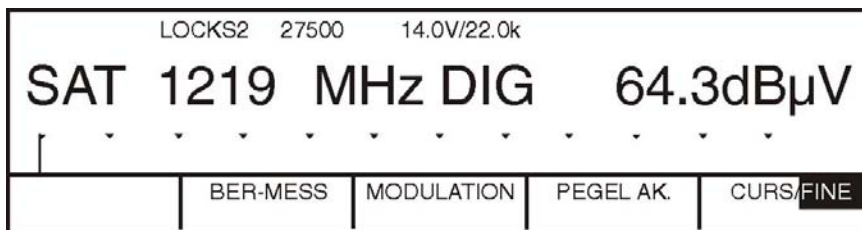

If the signal matches the standard set (DVB-S1 or DVB-S2), the device displays **LOCKS1** or **LOCKS2**; if not, **UNL-S1** or **UNL-S2** is displayed. If **UNL-S1** or **UNL-S2** is displayed, check the standard set and the symbol rate set.

The symbol rate and the standard for the signal to be measured must be known and then set accordingly on the receiver.

7.4.1 Changing the symbol rate

The symbol rate of the measuring receiver must be set in the 2 - 45 MSym/s range for **DVB-S1**. This allows SCPC (single channel per carrier) transmissions to be measured as well.

The symbol rate range is restricted to **10 – 30 Msym/s** in the **DVB-S2** standard.

Enter the symbol rate as follows:

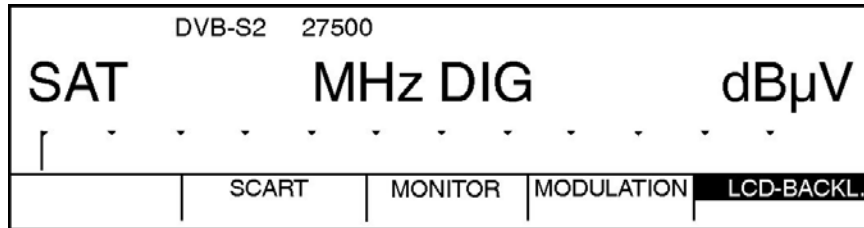

Press the **MODULATION** key (F4).

The following submenu opens:

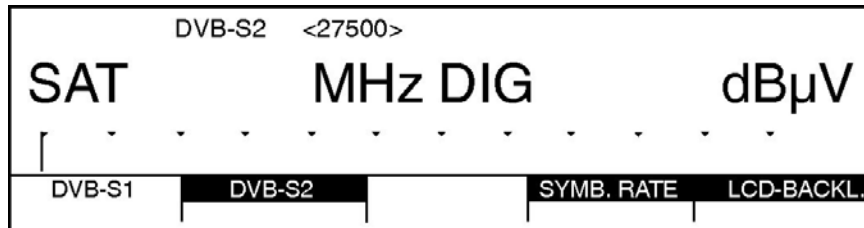

Then press the **SYMB. RATE** key (F4). The symbol rate in kSym/s (kBd) can now be entered via the numeric keypad. Press **ENTER** to save the changes.

#### 7.4.2 Level measurement

The level of the incoming signal can be measured as soon as the **LOCK-S1** or **LOCK-S2** message appears in the display. The bar graph makes it easy to follow changes in the level.

The acoustic level trend indicator can also be turned on if necessary.

Whereas the peak value is found when measuring the level of the analog video carrier, the receiver measures the mean noise power in the digital signals. The average noise power is measured in the middle of the carrier at 8 MHz, 4.3 MHz or 1 MHz bandwidth (depending on the symbol rate) and is corrected for bandwidth.

#### 7.4.3 Searching, frequency detuning

The **CURS/FINE** key (F5) can be used to set the functions of the arrow keys.

If set to **CURS**, the arrow keys can be used to control the MPEG-2 decoder (see "MPEG Decoder" chapter). Otherwise the **FINE-TUNE** keys are used to detune the receiver in the 1MHz or 125 kHz grid (see special program 72). The tuner is only detuned in the 500 kHz grid.

Start a search by pressing the **STATION** ↓ **SEARCH** ↑ keys (not with UNICABLE). The receiver then searches the SAT range for transmitters in the DVB-S1 and DVB-S2 standard in both positive and negative directions with the currently selected frequency, LNB feed and symbol rate as the starting point. The 27500kB and 22000kB symbol rates are also tested.

The receiver ends the search when a signal with the set symbol rate is found. The level must be > 42 dBµV here.

If a frequency has not yet been tuned, then the search starts from the lowest or highest SAT frequency.

The search can be stopped at any time by pressing and holding down **ENTER**.

#### 7.4.4 Assessing the picture and sound

The DVB-S2 receiver module (QPSK FRONT END) supplies the transport stream. It can contain several video and audio programs or only data-based services. To play back the programs, the delivery current must be analysed and decoded. This is done with the MPEG decoder.

For more information on using the MPEG decoder, see the MPEG Decoder chapter.



### 7.4.5 Testing the bit error ratio for DVB-S1 (CBER or VBER)

Press **BER-MEAS.** (F2) to access the bit error measurement menu.

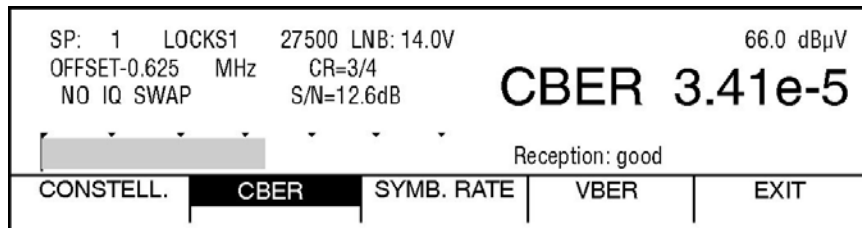

The bit error rate **before Viterbi** (CBER), the bit error rate before Reed-Solomon (VBER), the level, the carrier frequency offset, the code rate, a possible spectrum inversion and the S/N value are displayed.

Use the CBER and VBER keys to select the bit error rate **before Viterbi** (CBER – Channel Bit Error Rate) or **before Reed-Solomon** (VBER - Viterbi Bit Error Rate).

The bit error rate is indicated in three ways. It is represented as a number with exponential notation, a bar graph in logarithmic format and as a qualitative assessment. The qualitative assessment comprises the following categories:

Bit error rate	Reception quality
<1.00e-6	good
1.00e-6<BER<1.00e-3	conditional
>1.00e-3	poor

The error correction method implemented in the Viterbi decoder is used to measure the CBER.

The bit current is compared before and after the decoder and deviating bits are summed up with a bit error counter.

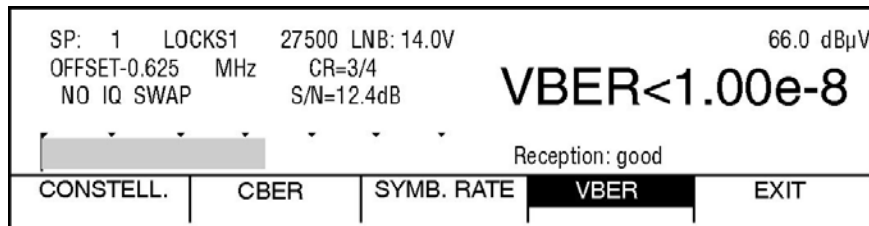

The error correction method implemented in the Reed-Solomon decoder is used to measure the VBER. At this point, the bit error rate can be measured in the receiver with all 3 DVB reception modules (DVB-S, DVB-C and DVB-T) in the same way. The following conclusion can therefore be made for all three reception types.

The signal can be considered error free if the bit error rate is 2.00e-4 (quasi error free, QEF), since statistically speaking only one non-correctable error occurs per hour.

However, even slight signal deterioration can cause complete reception failure.

If the bit error rate is VBER 5.00e-8, for example, then 5 defective bits are received out of 100 million. The measuring time for the bit error rate depends on the symbol rate. As an example, a symbol rate of 27500kBd results in a measuring time of about 2 seconds.

### 7.4.6 Testing the bit error rate for DVB-S2 (CBER or PER)

Press **BER-MEAS.** (F2) to access the bit error measurement menu.

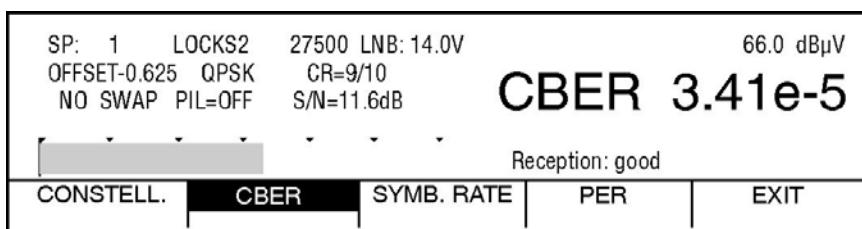

The bit error rate **before correction** (CBER), the bit error rate **after correction** (PER, packet error), the level, the carrier frequency offset, the modulation (QPSK or 8PSK) the code rate (CR), a possible spectrum inversion, the pilot signal (PIL) and the S/N value are displayed.

Press the CBER and PER function keys to toggle between the bit error rate **before correction** (CBER) and the bit error rate **after correction** (PER).  
 The bit error rate is indicated in two ways. It is represented as a number with exponential notation and a bar graph in logarithmic format.

7.4.7 *Measuring the carrier frequency offset*

The DVB-S2 receiver module can demodulate digital signals as long as the difference between the transmitted and incoming frequency is less than 20 % of the symbol rate. The frequency difference is displayed in MHz with a plus or minus sign. A positive value means the incoming frequency is higher than the transmitting frequency. Measuring the frequency deviation can be used to test the accuracy of the LNB frequency.

7.4.8 *Measuring the IQ phase position*

**IQ SWAP** and **NO SWAP** indicate whether the incoming digital signal is in the default position (NO SWAP) or the inverted position (IQ SWAP). A signal can be rearranged to move it from the default position to the inverted position.

7.4.9 *Measuring the signal to noise ratio (S/N) in the baseband*

The S/N ratio is measured in the baseband directly after the demodulator. The measuring range is 2-18dB.  
 If noise is the only interference factor, which is usually the case with satellite transmission, then the S/N ratio is identical to the modulation error rate (MER).

**For DVB-S1:**

A bit error rate (VBER) of approx. 2.00e-4 before the Reed-Solomon decoder is required for a virtually error-free QPSK signal. At this signal quality the S/N value is approx. 7.3 dB with a code rate of 3/4. The S/N value can provide information about the system reserve. If the measuring instrument indicates an S/N of 10.2 dB, for example, then the system has a reserve of 2.9 dB. The C/N can therefore deteriorate by 2.9 dB (due to bad weather perhaps) without becoming noticeable in the picture and sound played back through the MPEG-2 decoder. For this reason always set the S/N value to the maximum when adjusting a parabolic antenna. The S/N value is also directly related to the bit error rate before Viterbi (CBER).

**For DVB-S2:**

A new error correction procedure is used for this (LDPC and BCH). The bit error rate before correction (CBER) is used to assess the signal quality.

7.4.10 *Constellation diagram (QPSK,8PSK)*

Press **CONSTELL.** (F1) to access a display of the constellation diagram (see "Constellation Diagram" chapter).

7.5 **DVB-C (QAM) or DOCSIS**

QAM (Quadrature Amplitude Modulation) is a digital modulation method for transmitting digital audio and video signals via cable (DVB-C). 16QAM, 32QAM, 64QAM, 128QAM and 256QAM are the modulation schemes defined in the DVB-C standard. In these schemes the carrier frequency accepts 16, 32, 64, 128 or 256 phases and amplitude states. The test receiver can demodulate all schemes (256 QAM only optional). The FEC (Forward Error Correction) has external error protection (Reed-Solomon decoder). It can, to a certain limit, remove bit errors caused by various effects in the transmission channel. The test receiver uses this error correction mechanism to determine the bit error rate.

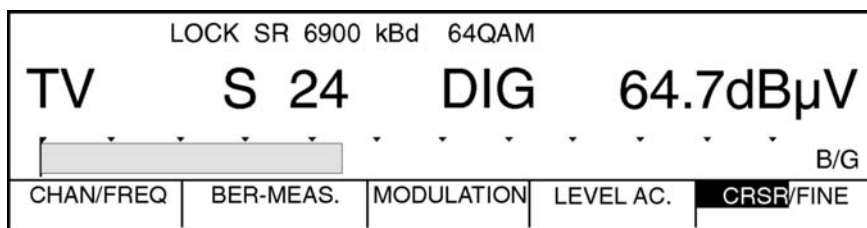

If a signal with the set modulation is present, the instrument responds with **LOCK** in the display; otherwise **UNLOCK** appears.

If the instrument shows **UNLOCK**, the set symbol rate should be checked first. The symbol rate for the signal to be measured must be known and then set accordingly on the receiver. In a 7MHz channel, the symbol rate is typically 6111kBd. In 8MHz channels the rate is either 6875kBd or 6900kBd.

7.5.1 Changing the symbol rate and modulation

The symbol rate of the receiver must be set in the 5 - 7.2MSym/s (5000-7200kBd) range.

Meters in a later version (delivery later November 2003) are covering a symbol rate from 500 – 7200 kBd.

The symbol rate and the type of modulation are displayed in the top line of the display. No symbol rate can be set for modulation type DVB-T (COFDM).

After pressing the **MODULATION** (F3) function key, the following is displayed:

SR 6900 kBd 64QAM				
TV	S . .	DIG	dBµV	
B/G				
DVB-T	DVB-C	DOCSIS	SYMB. RATE	EXIT

**Changing the symbol rate:**

First, press the **SYMB. RATE** function key (F4). Then, the symbol rate in kSym/s (kBd) can be entered using the numeric keypad. Press **ENTER** to save the changes.

**Changing the type of modulation:**

The modulation type that is selected is displayed inverted.

The **DVB-T** (F1) function key switches to the COFDM modulation, as is used in digital terrestrial television. It only appears if the COFDM option is installed.

The **DVB-C** (F2) function key opens a submenu in which the QAM16, QAM32, QAM64, QAM128 and QAM256 modulation types can be selected. These modulation types are used in digital cable television.

The **DOCSIS** (F3) function key opens a submenu in which the EU-DOCSIS 64QAM, EU-DOCSIS 256QAM, US-DOCSIS 64QAM and US-DOCSIS 256QAM modulation types can be selected.

Set the modulation by pressing the appropriate function key.

7.5.2 Level measurement

The level of the incoming QAM signal can be measured as soon as the **LOCK** message appears in the display. The bar graph makes it easy to follow changes in the level.

The acoustic level trend indicator can also be turned on if necessary.

Whereas the peak value is found when measuring the level of the analog video carrier, the receiver measures the mean noise power in the QAM signals. The instrument measures the mean noise power in the centre of the carrier with a 4 MHz, 1MHz or 200 kHz bandwidth (depending on the symbol rate) and carries out a bandwidth correction.

7.5.3 Searching, frequency detuning

How the arrow keys function can be determined with the **CURS/FINE** key (F5).

If set to **CURS**, the arrow keys can be used to control the MPEG-2 decoder (see "MPEG-2 Decoder" chapter). Otherwise the **FINE-TUNE** keys of the receiver can be used to detune in the 50 kHz grid.

Start a search by pressing the **STATION**↓ **SEARCH**↑ keys. The receiver then searches the VHF-S or VHF/UHF range for QAM-modulated signals in both positive and negative directions with the current channel selection, symbol rate and modulation as the starting point.

The 6900kB, 6875kB and 6111kB symbol rates are also tested, as are the QAM64 and QAM256 modulation types. With QAM256, the 6111kB symbol rate is not tested in addition:

The receiver ends the search when a signal with the set symbol rate and modulation is found. The level must be > 35 dBµV here.

If a channel has not yet been tuned, then the search starts from the lowest or highest channel in the TV range.

The search can be stopped at any time by pressing and holding down **ENTER**.

### 7.5.4 Assessing the picture and sound

The QAM receiver module (QAM FRONT END) supplies the so-called transport stream. It can contain several video and audio programs or only data-based services. To play back the programs, the delivery current must be analysed and decoded. This is done with the MPEG-2 decoder (optional). For more information on using the MPEG-2 decoder, see the "MPEG-2 Decoder" chapter.

### 7.5.5 Measuring the bit error rate (BER)

Press **BER-MEAS.** (F2) to access the bit error measurement menu.

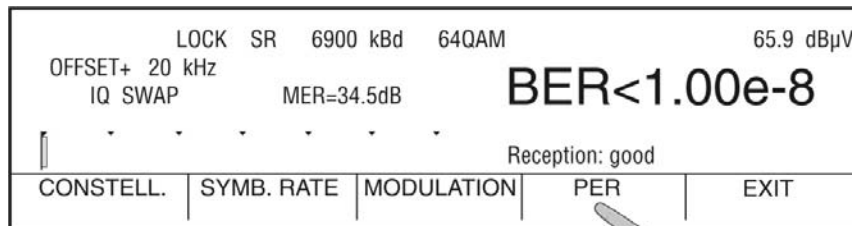

(only with instruments which 256QAM and Tuner TD1316)

The bit error rate before Reed-Solomon (BER), the level, the carrier frequency offset, possible spectrum inversion and the modulation error ratio (MER) are displayed.

Instruments with QAM 256 show the symbol rate inverted if the adjusted rate deviates from the real one by more than 1 ‰.

The bit error rate is indicated in three ways. It is represented as a number with exponential notation, a bar graph in logarithmic format and as a qualitative assessment.

The qualitative assessment comprises the following categories:

<b>Bit error rate:</b>	<b>Reception quality:</b>
<1.00e-6	good
1.00e-6<BER<1.00e-3	conditional
>1.00e-3	poor

The error correction method implemented in the Reed-Solomon decoder is used to test the bit error rate. Bit error rate measurement at this point in the receiver is identical for all three DVB reception modules (DVB-S, DVB-C and DVB-T). The following conclusion can therefore be made for all three reception types.

The signal can be considered error free if the bit error rate is 2.00e-4 (quasi error free, QEF), since statistically speaking only one non-correctable error occurs per hour.

However, even slight signal deterioration can cause complete reception failure.

If the bit error rate is BER 5.00e-8, for example, then 5 defective bits are received out of 100 million. The measuring time for the bit error rate depends on the symbol rate. As an example, a symbol rate of 6900kBd results in a measuring time of about 2 seconds.

### 7.5.6 Measuring the carrier frequency offset

The QAM-FRONT-END can demodulate QAM signals as long as the difference between the transmitted and incoming frequency is less than 8% of the symbol rate. The frequency difference is displayed in kHz with a plus or minus sign. A positive value means the incoming frequency is higher than the transmitting frequency. Measuring the frequency deviation can also be used to test the frequency accuracy of transmodulators (QPSK-QAM converter).

### 7.5.7 Measuring the IQ phase position

**IQ SWAP** and **NO IQ SWAP** indicate whether the incoming QAM signal is in the default position (NO IQ SWAP) or the inverted position (IQ SWAP).

A signal can be rearranged to move it from the default position to the inverted position.

This can be done with transmodulators.

### 7.5.8 Measuring the modulation error rate (MER)

The modulation error rate (MER) is a value that comprises all of the interference factors of a digitally-modulated signal. MER is therefore a measure of signal quality.

The higher the MER, the better the incoming signal. A high modulation error rate means a low bit error rate. The MER is always displayed in dB.

### 7.5.9 Measuring the package error rate (PER) (only for devices with 256QAM and tuner TD1316)

PER measurement can be performed with all new devices and all suitably retrofitted devices.

Press **PER** (F4) in the bit error measurement (BER) menu to switch the device to PER measurement mode.

The following menu appears, and PER measurement commences.

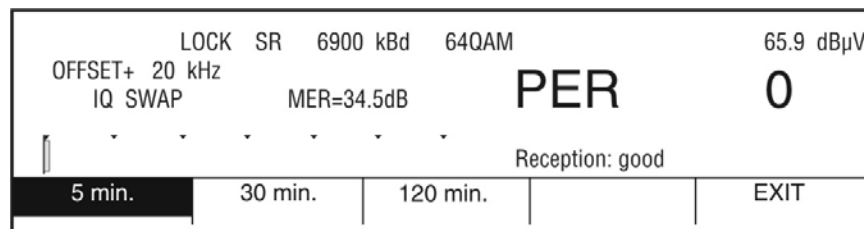

In this mode, the number of package errors is shown in the display. Package errors are added up until you leave this mode or the number reaches 60,000. The PER, MER, and level deviation are graphically recorded on the display.

The initial level measured is used as a reference value. The measurement period can be set to 5 minutes, 30 minutes, or 120 minutes using the function keys. Every time one of these function keys is pressed, measurement is restarted.

Individual PER values are displayed as blue vertical bars, MER values as green dots, and level deviation values as red vertical bars. If the input splitter changes the input attenuation, the level deviation is displayed as a white bar. This results in a sudden change of signal level that can cause package errors. Because of this, package errors are not recorded for 3 seconds when this happens.

At the bottom of the display, a yellow progress bar displays the progress of the measurement. If the signal measured becomes so poor that the device goes to **UNLOCKED**, the progress bar turns red and no PER or MER values can be recorded.

When the measurement period is finished, the graphical recording is no longer updated, but the number of package errors continues to be counted and shown in the LCD display.

Package errors are caused by short signal interruptions or by signal phase jitter. Receivers and our measuring receivers can compensate for phase jitter to some extent.

To determine whether the measurement signal is affected by too much phase jitter, you can switch the device to **PHASE JITTER** mode in the constellation diagram menu. This reduces the measuring receiver's jitter correction to make phase jitter visible in the constellation diagram and more easily recognizable when measuring the package error rate.

**PHASE JITTER** mode is indicated by the appearance of the word **PHASE** in inverse colour in the lower right corner of the display. As soon as you navigate to another area or leave DVB-C mode, **PHASE JITTER** mode is switched off.

Example of a graphical recording on the display:

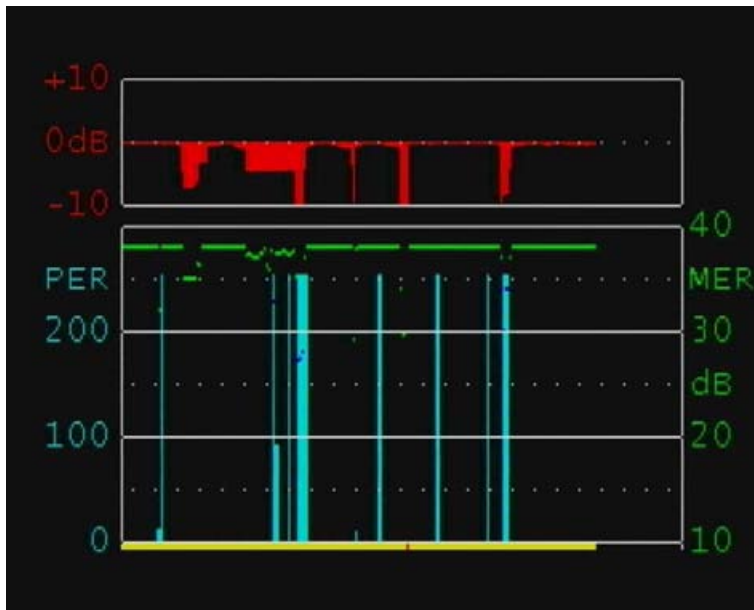

### 7.5.10 DOCSIS

This standard is used downstream in interactive cable networks (transmission to the subscriber). The measuring receiver can receive signals in the DOCSIS standard. To do this, the appropriate **DOCSIS** standard must be set in the **MODULATION** menu.

The QAM receiver module (QAM-FRONT-END) is set to 64QAM with a 6952 kBd symbol rate in **EU-DOCSIS 64QAM**.

The QAM receiver module (QAM-FRONT-END) is set to 256QAM with a 6952 kBd symbol rate in **EU-DOCSIS 256QAM**.

The QAM receiver module is set to 64QAM with a 5057 kBd symbol rate in **US-DOCSIS 64QAM**.

The QAM receiver module is set to 256QAM with a 5361 kBd symbol rate in **US-DOCSIS 256QAM**.

DOCSIS 256QAM can only be set in instruments that can also receive 256QAM.

The corresponding symbol rate and the type of modulation are displayed in the top line of the display.

Since the US-DOCSIS standard is not identical to the DVB-C standard, not all measurements can be carried out. For this reason, the bit error rate measurement is suppressed and the MPEG-2 decoder (if installed) is switched off in US-DOCSIS.

### 7.5.11 Constellation diagram (QAM)

Press **CONSTELL.** (F1) to receive a display of the constellation diagram (see "Constellation Diagram" chapter).

## 7.6 DVB-T (COFDM) optional

You can access the COFDM modulation type by pressing **MODULATION**.

COFDM (Coded Orthogonal Frequency Division Multiplexing) is a digital modulation method for transmitting digital audio and video signals via terrestrial radio broadcasting (DVB-T). The method is designed for use in single frequency networks (SFC).

There are two different methods:

1. 2k: Transmits 1705 adjacent single carriers in one channel.
2. 8k: Transmits 6817 adjacent single carriers.

This method allows single frequency networks to be used since it prevents multipath reception (fading) from partially or completely destroying certain frequencies. The modulation parameters can be adapted to a variety of good transmission channels. Single carriers with QPSK, 16QAM or 64QAM can therefore be modulated. Differing code rates affect the efficiency of the Viterbi algorithm. The guard interval can be adjusted to various transmitted intervals in the single frequency network. The COFDM method differentiates three types of single carriers. The data carrier transmits the actual audio and video data. As mentioned above, they are transmitted with QPSK, 16QAM or 64QAM modulation.

The pilot carriers contain reference information and are transmitted at an increased level with BPSK. The TPS carriers (Transmission Parameter Signalling) transfer reception information. They are transmitted using the mean power of data carriers and with BPSK.

The COFDM receiver module (COFDM-FRONT-END) automatically sets the modulation parameters based on the information provided by the TPS carriers. The receiver is also prepared for hierarchical modulation with  $\alpha=1$ ,  $\alpha=2$  or  $\alpha=4$ .

The FEC (Forward Error Correction) has internal and external error protection (Viterbi and Reed Solomon decoder, respectively).

These decoders can, to a certain limit, remove bit errors caused by various effects in the transmission channel. The receiver employs this error correction method to determine the bit error rate.

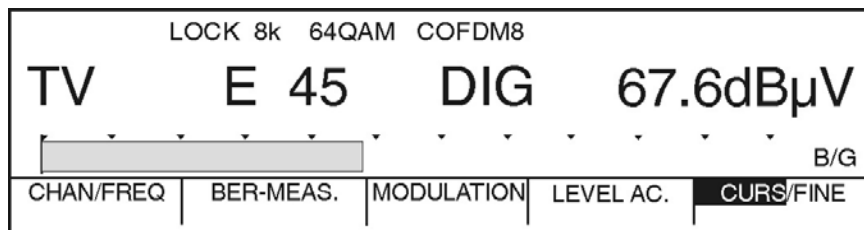

If a signal with the set modulation is present, the instrument responds with **LOCK** in the display; otherwise **UNLOCK** appears.

The receiver automatically sets the modulation parameters contained in the TPS data. They are displayed in the first line next to the lock status. In this example the receiver receives a COFDM signal that is modulated in the 8K mode with 64QAM.

The 8 in the designation COFDM8 indicates that the device is set to a COFDM signal bandwidth of 8 MHz. This bandwidth is automatically set according to the selected channel.

In our example: E45 is an 8 MHz channel.

For special cases, you can use the special MODE 82 program to switch from automatic to manual. Signal bandwidths of 6, 7 or 8 MHz can be set manually. The setting will remain until the instrument is switched off or another setting is selected.

If the remote supply voltage has been switched on, the designation COFDM8 is overwritten by the remote supply voltage display.

### 7.6.1 Level measurement

The level of the incoming COFDM signal can be measured as soon as the **LOCK** message appears in the display. The bar graph makes it easy to follow changes in the level.

The acoustic level trend indicator can also be turned on if necessary.

Whereas the peak value is found when measuring the level of the analog video carrier, the receiver measures the mean noise power in the COFDM signals. The instrument measures the mean noise power in the centre of the carrier with a 4MHz bandwidth and carries out a bandwidth correction.

### 7.6.2 Searching, frequency detuning

How the arrow keys function can be determined with the **CURS/FINE** key (F5).

If set to **CURS**, the arrow keys can be used to control the MPEG-2 decoder (see the "MPEG-2 Decoder" chapter). Otherwise the **FINE-TUNE** keys of the receiver can be used to detune in 50kHz increments.

Start a search by pressing the **STATION**↓ **SEARCH**↑ keys. The receiver then searches the VHF-S or VHF/UHF range for COFDM-modulated signals in both positive and negative directions with the current channel selection as the starting point. The receiver ends the search when a COFDM-modulated signal is found. The level must be > 35 dBμV here. If a channel has not yet been tuned, then the search starts from the lowest or highest channel in the TV range. The search can be stopped at any time by pressing and holding down **ENTER**.

7.6.3 Assessing the picture and sound

The COFDM receiver module (COFDM FRONT END) supplies the so-called delivery current. It can contain several video and audio programs or only data-based services. To play back the programs, the delivery current must be analysed and decoded. This is done with the MPEG-2 decoder (optional). For more information on using the MPEG-2 decoder, see the "MPEG-2 Decoder" chapter.

7.6.4 Measuring the bit error rate (CBER (from October 2002) or VBER)

Press **BER-MEAS.** (F2) to access the bit error measurement menu.

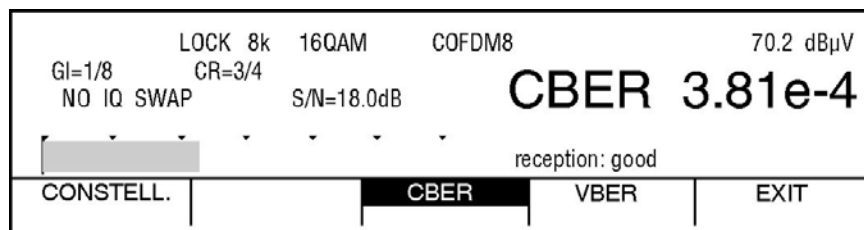

The bit error rate before Viterbi (CBER), the level, the guard interval, the code rate, possible spectrum inversion and the S/N value are displayed.

Use the **CBER** (F3) and **VBER** (F4) keys to select the bit error rate before Viterbi (CBER – Channel Bit Error Rate) or before Reed-Solomon (VBER - Viterbi Bit Error Rate).

The bit error rate is indicated in three ways. It is represented as a number with exponential notation, a bar graph in logarithmic format and as a qualitative assessment.

The qualitative assessment comprises the following categories:

<b>Bit error rate:</b>	<b>Reception quality:</b>
<1.00e-6	good
1.00e-6<BER<1.00e-3	conditional
>1.00e-3	poor

**Note!**  The bit error rate before Reed Solomon (VBER) is always used for the qualitative assessment.

The error correction method implemented in the Viterbi decoder is used to measure the CBER. The bit current is compared before and after the decoder and deviating bits are summed up with a bit error counter.

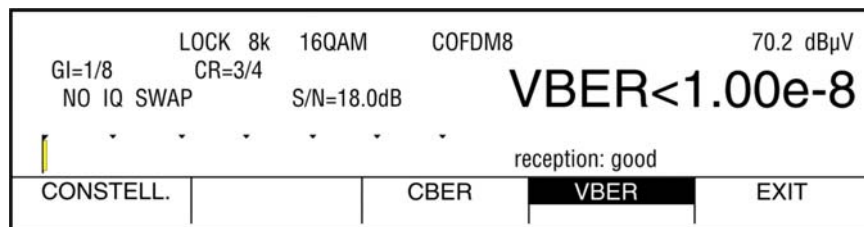

The error correction method implemented in the Reed-Solomon decoder is used to measure the VBER. Bit error rate measurement at this point in the receiver is identical for all three DVB reception modules (DVB-S, DVB-C and DVB-T).

The following conclusion can therefore be made for all three reception types. This is why the qualitative assessment of the signal is always derived from this bit error measurement. The signal can be considered error free if the bit error rate is 2.00e-4 (quasi error free, QEF), since statistically speaking only one non-correctable error occurs per hour.



However, even slight signal deterioration can cause complete reception failure.

If the bit error rate is VBER  $5.00e-8$ , for example, then 5 defective bits are received out of 100 million. The measuring time for the bit error rate depends on the FFT mode. As an example, an 8k FFT results in a measuring time of about 2 seconds.

### 7.6.5 Measuring the IQ phase position

**IQ SWAP** and **NO IQ SWAP** indicate whether the incoming COFDM signal is in the default position (NO IQ SWAP) or the inverted position (IQ SWAP).

A signal can be rearranged to move it from the default position to the inverted position.

### 7.6.6 Measurement of signal-noise distance (S/N) or rather the modulation error rate (MER) in the base band

All disturbances will be measured with the modulation error rate (MER).

If hissing is the only disturbance then the S/N-factor is identical to the modulation error rate (MER). In the instruments from June 2009 on, the MER-factor is shown instead of the S/N-factor.

The S/N (MER-factor) value is measured in the baseband directly after the demodulator. This value is nearly identical to the carrier noise ratio (C/N) at the antenna input of the test receiver.

A VBER (before Reed-Solomon) bit error rate of approx.  $2.00e-4$  is required for a virtually error-free COFDM signal. If the COFDM signal is modulated with 16QAM and the code rate is 3/4, then an S/N value of approx. 13.5dB is required for this signal quality. The S/N value can provide information about the system reserve. If the measuring instrument indicates an S/N (MER) of 18dB, for example, then the system has a reserve of 4.5dB.

The C/N (MER) can therefore deteriorate by 4.5dB (perhaps due to bad weather) without it becoming noticeable in the picture and sound played back through the MPEG-2 decoder.

For this reason always set the S/N (MER-factor) value to the maximum when adjusting an array antenna. The S/N (MER-factor) value is directly related to the bit error rate before Viterbi (CBER), which the instrument can measure as well.

### 7.6.7 Impulse response

It is helpful to measure the impulse response for DVBT for setting up a receiving antenna - especially in situations where reception is difficult. Keyword multipath reception (fading). If a receiving antenna receives the DVBT signal from multiple directions with differing transit times and differing field strengths, the individual signals superimpose upon each other to form a sum signal.

In order to optimise reception, the receiving antenna should be oriented so that the level of the secondary impulse (or impulses) is minimised.

Because DVBT is made up of several narrow-band single carriers (COFDM), single carriers may occasionally be notably attenuated through superimposition. Because information is divided among all carriers with respect to time, the DVBT system can process this to a certain degree without any problem.

However, the impulse response can be used to detect this scenario before it causes problems in reception. The basis for measuring the impulse response is information in the channel transmission function. The DVBT channel decoder acquires this through the pilot carriers that are transmitted with DVBT. Through calculating the IFFT, you can obtain the impulse response from the channel transmission function.

The measuring receiver must receive a DVBT signal in order to display the impulse response. The device must first be tuned to a corresponding channel and changed to the bit error rate measurement mode with the **BER-MEAS** (F2) function key. The impulse response measurement can be started with the **IMPULSRESP** (F2) function key.

The impulse response is now graphically displayed on the screen.

The following figure shows a sample impulse response.

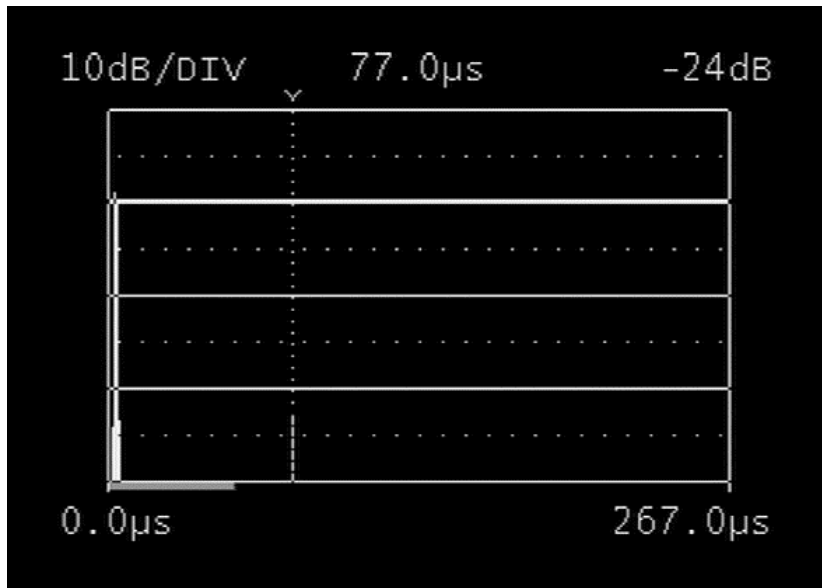

A primary impulse (primary reception direction) is shown on the left edge of the display. Additional smaller impulses can be seen to the right, in an interval with respect to time.

You can move the cursor (vertical dotted line) to a secondary impulse using the arrow keys **FINE <--TUNE-->**.

The level of the secondary impulse relative to the primary impulse as well as its delay in [ $\mu$ s] is shown on the upper edge of the display and is marked with the cursor. Press the function key **km** (F1) to convert and display the delay in kilometers. This is based on the fact that the signal travels at the speed of light.

A bar on the lower line of the graphic indicates the progress of the measurement. At the end of each run, the measured values are updated and displayed in the upper edge of the screen.

The distance of the horizontally drawn line is 10 dB.

### 7.6.8 Constellation diagram (COFDM)

Press **CONSTELL.** (F1) to access a display of the constellation diagram (see "Constellation Diagram" chapter).

## 7.7 Constellation diagram

The constellation diagram is a graphical representation of a digitally modulated signal in a two dimensional coordinate system. Individual signal states can be viewed as source vectors with I (inphase, x-axis) and Q (quadrature, y-axis) components.

Only the peaks of the vectors are shown in diagram. Depending on modulation method, there is a varying number of decision fields within the two dimensional field. These decision fields correspond to a specific bit combination. For a real signal charged with different interferences, however, not all nominal states can be reached each time. The peaks of the vectors are focused much more on ideal states at specific intervals (depending on the signal quality). The mean between to ideal states is designated as the decision limit (indicated in the diagram by the horizontal and vertical lines).

A signal with enough interference to move several signal states beyond the decision limit will result in bit errors. In summary, this means: The better all signal states centre on the ideal states (the smaller the signal clouds are), the better the signal.

The instrument displays the constellation diagram for all 3 DVB receiver units in real time (COFDM only with installed COFDM option). Real time means:  $2^{16}$  events (symbols) are traced in one measuring interval, which corresponds to a repetition rate of 50/s with, for example, a 64QAM and a symbol rate of 6900 kBd.

In addition, the test receiver records the frequency of the signal states during the measuring interval.

The signal states are coloured according to frequency. Blue, green, yellow and red represent increasing frequency. This gives a three dimensional look to the constellation diagram.

---

**Important!**  For devices with QPSK cards (from April 2004 to appr. October 2006) and measurable BER pre Viterbi, the frequency offset is automatically compensated for after accessing the QPSK constellation diagram.

---

### 7.7.1 Accessing the constellation diagram

If the instrument is in the bit error rate measuring mode for DVB-S, DVB-C or DVB-T, then press **CONSTELL.** (F1) to access a display of the constellation diagram.

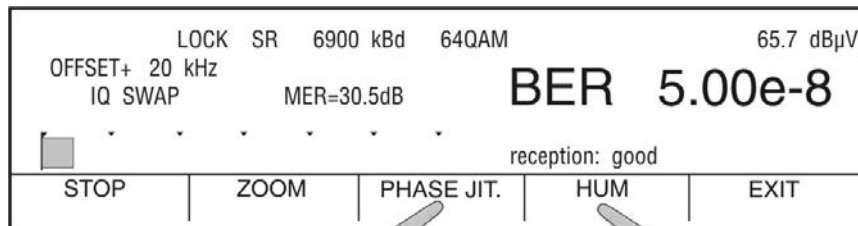

(only with instruments which 256QAM and Tuner TD1316) only with QAM

### 7.7.2 Freezing the diagram

You can freeze the diagram by pressing **STOP** (F1). Press the key again to resume.

### 7.7.3 Zoom function

This function allows you to zoom any quadrant of the diagram to full screen width.

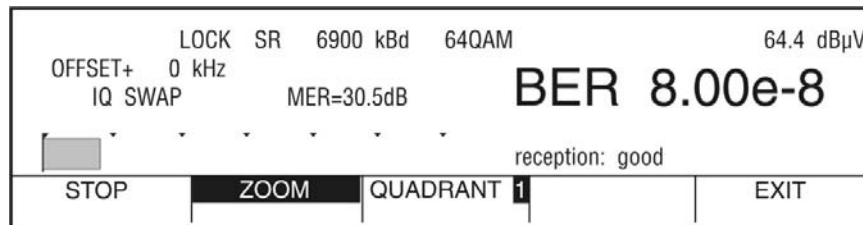

Press **ZOOM** (F2) to activate this function. With the **QUADRANT** key (F3) you can select one of the four quadrants in sequence.

Press **ZOOM** (F2) again to return to the normal window size.

The zoom function for QPSK is only available for devices with QPSK cards (from October 2002) and measurable BER pre Viterbi.

### 7.7.4 Measuring phase jitter with QAM (only for devices with 256QAM and tuner 1316)

The measuring receiver corrects most of the phase jitter in the measurement signal when in normal mode. To make phase jitter visible in the constellation diagram, phase jitter correction can be reduced by switching to **PHASE JITTER MEASUREMENT** mode.

To switch to this mode, press **PHASE JIT.** (F3) in the constellation diagram menu. When this mode is activated, the function key is displayed in inverse colour. The word **PHASE** is also displayed in inverse colour in the lower right corner of the display. Press this key again to switch off **PHASE JITTER** mode.



The **PHASE JIT.** (F3) function key is only visible when **ZOOM** is not activated.

Example of a constellation diagram with phase jitter:

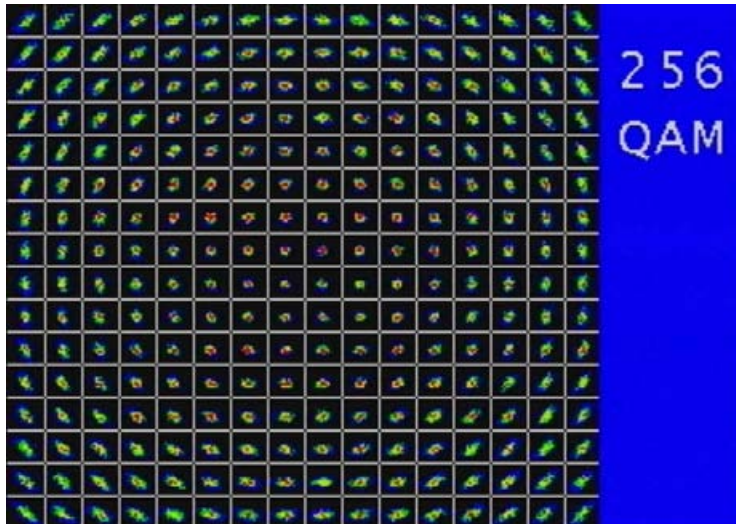

### 7.7.5 Hum measurement at QAM

The QAM receiver module largely regulates the hum of the receiver signal automatically. Press the function key **HUM** (F4) to switch the control function off and show the influence of the hum in the constellation diagram. Switching the control function off is only effective in the constellation diagram. If a measured value printout is triggered using the **PRINT** key when the function key **HUM** (F4) is activated, the measured values are printed with and without the hum measurement without considering the special program 74.

### 7.7.6 Single carrier representation with COFDM

A COFDM signal consists of 1705 (2k mode) or 6817 (8k mode) single carriers.

Use the **SINGLE CAR** key (F4) to select either a superimposed display of all single carriers or a separate display of single carriers.

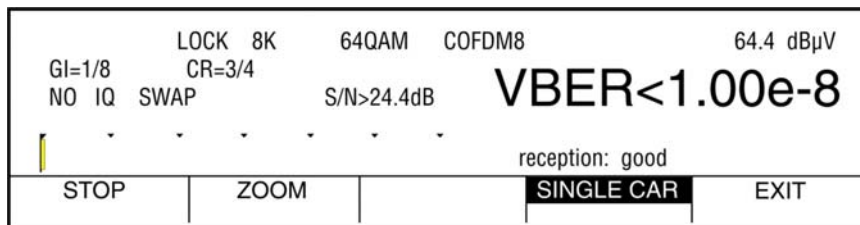

In the single carrier representation, the index of carriers appears on the right margin of the diagram.

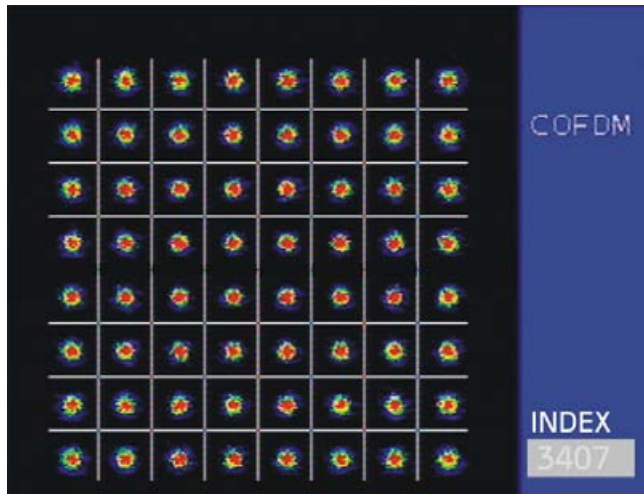

A new index can be entered using the numeric keypad. The number is highlighted in red during entry. Confirm the entry by pressing **ENTER**. The following applies:

For 8k FFT, indexes of 0.6816 can be entered.

For 2k FFT, indexes of 0.1704 can be entered.

For invalid entries, the last valid entry remains.

For single carrier representation, note that the repetition rate is about 2/s for 2k FFT and about 0.5/s for 8k FFT. The reason for this is that a single carrier changes its modulation state only once per COFDM symbol.

For this representation  $2^{11}$  events are traced instead  $2^{16}$  so as not to further reduce the repetition rate.

This representation allows you to analyse individual data, pilot or TPS carriers. Certain modulation errors (amplitude imbalance, IQ phase error, etc.) can only be detected in the central carriers. These are preset every time you access the constellation diagram.

---

**Note:**  TPS carriers do not cause clouds to develop in the constellation diagram. They are subject to a **softdecision** in the demodulator that only depicts discreet pixels in the diagram.

---

7.8 Examples of constellation diagrams with various errors and their causes

DVB-S (QPSK)

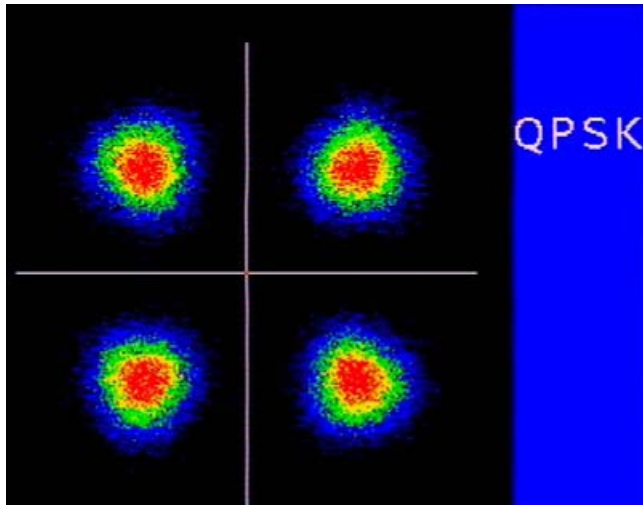

Real QPSK signal

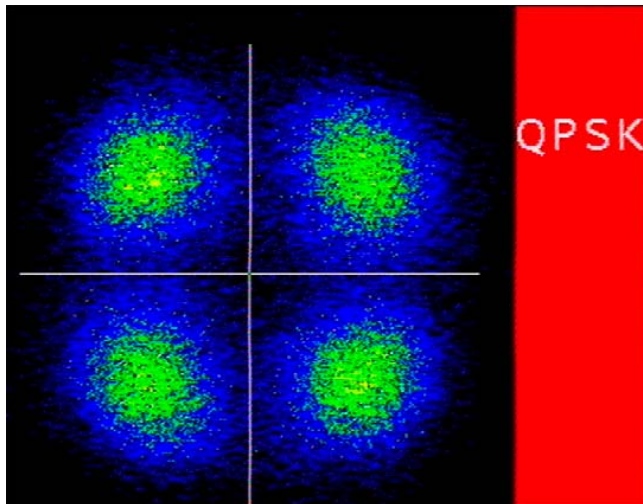

QPSK signal with poor cross-polarization coupling

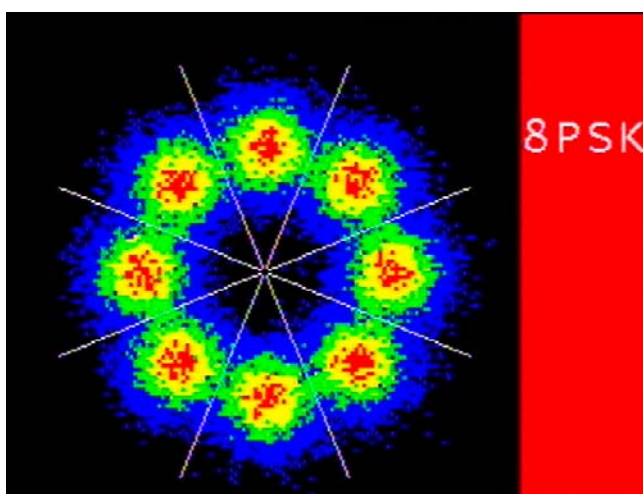

Real 8PSK signal



DVB-C (QAM)

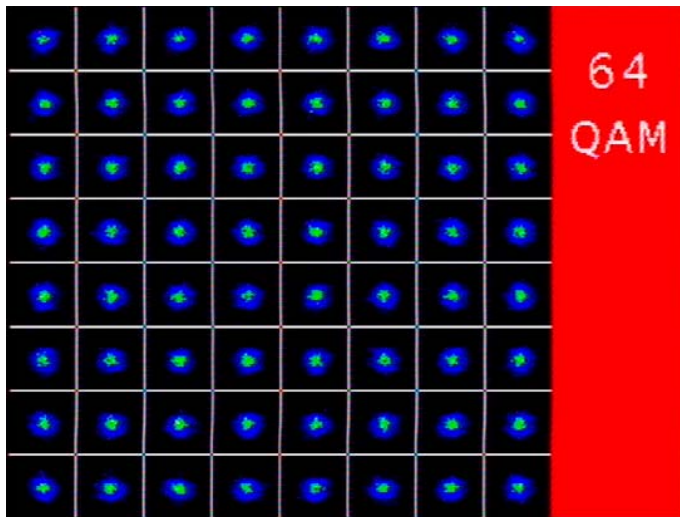

Real 64QAM signal

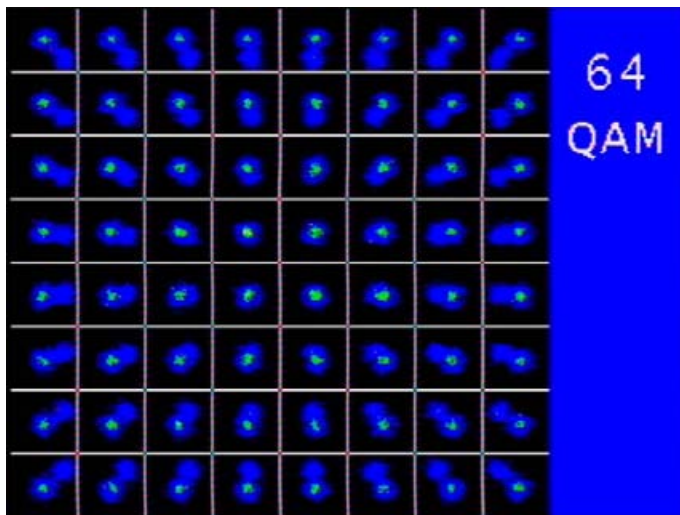

64QAM signal with IQ amplitude hum  
Possible cause: faulty amplifier

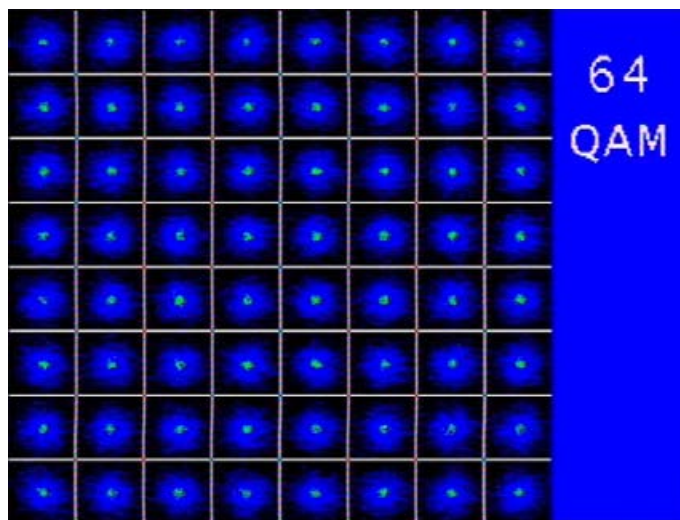

Poor signal-to-noise (S/N ratio)  
Possible cause: oblique positions, reflections, intermodulations, defective amplifier, defective transmodulator (QPSK-QAM)

DVB-T (COFDM)

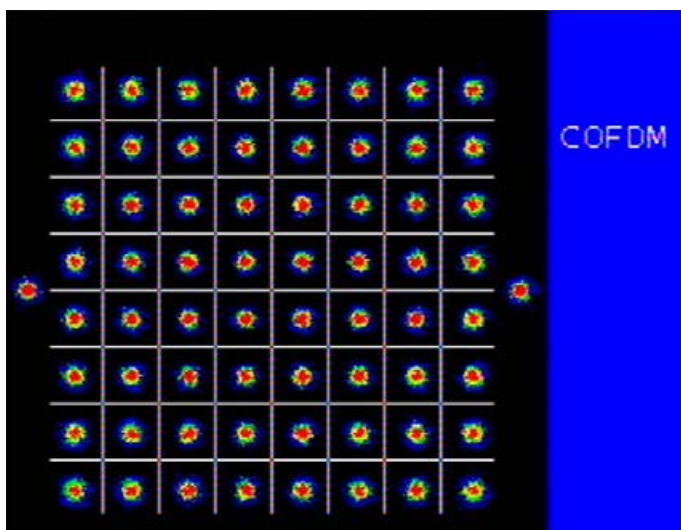

**Real COFDM signal with 64QAM**  
single carrier modulation  
One recognises the pilot carriers on the horizontal axis

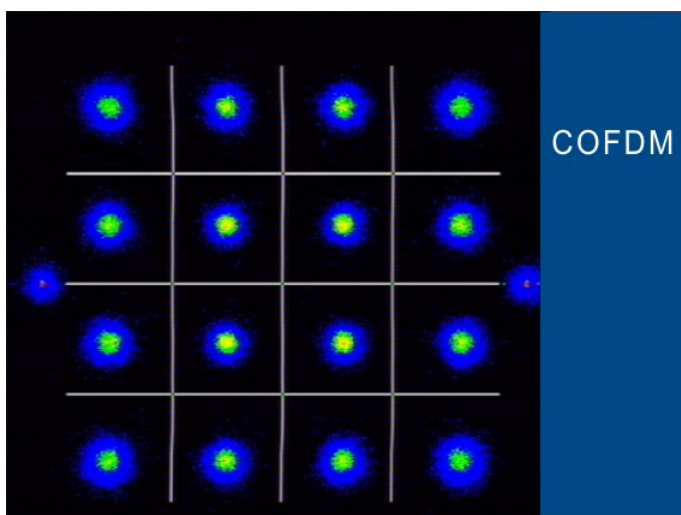

**Real COFDM signal with 16QAM**  
single carrier modulation  
One recognises the pilot carriers on the horizontal axis

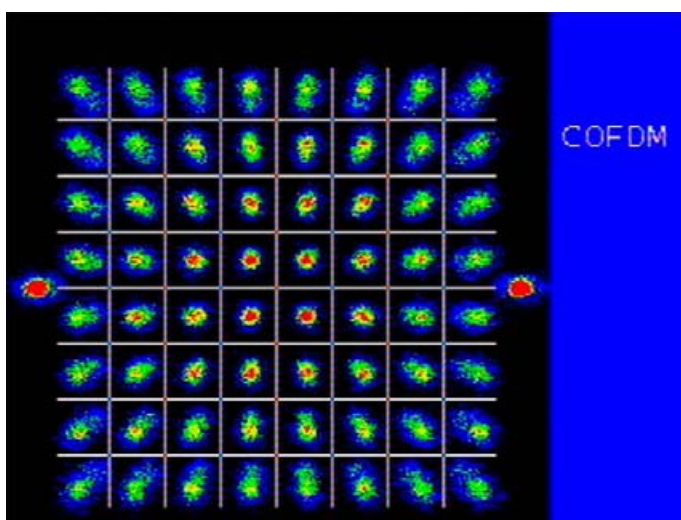

**COFDM signal with amplitude hum**  
Possible cause: faulty amplifier



## Chapter 8

### MPEG decoder (optional)

---

#### 8.1 Introduction

##### 8.1.1 DVB and MPEG-2

Digital television broadcasting is based on the DVB project. DVB uses the methods established in the MPEG-2 standard for coding video and audio sources.

##### - Source coding and multiplexing

In order to be able to transmit the high data rates that occur with the digitization of video and audio signals in a cost-effective way, the volume of data must be reduced using special compression methods.

##### - MPEG-2 video source coding (ISO/IEC 13818-2)

Simply put, the video compression method works according to the following principle:

The complete picture information is only transmitted after x number of pictures. In between only changes from one picture to the next are transmitted. This can be accomplished due to complex computations algorithms.

##### - MPEG-1/2 Layer II audio source coding (ISO/IEC 13818-3)

The audio data reduction works according to the psychoacoustic model of the human ear. Here, the sensitivity of hearing perception is distributed in a spectral way. The volume of data can be significantly reduced with little loss of quality by using special algorithms.

##### - Multiplexing

Video and audio data from one or more programs are transmitted in the MPEG transport stream (TS) in time division multiplexing. In addition, the transport stream contains service information for the receiver in order to demultiplex programs as well as Teletext and other data services.

##### - Satellite, cable and terrestrial transmission of SDTV (Standard Definition TV)

In order to transmit digital TV via satellite, cable and terrestrial transmission media, the DVB-S transmission method has been developed for satellite, while DVB-C serves cable and DVB-T serves terrestrial. Each respectively has the task of transporting the MPEG multiplex (transport stream) from the transmitter to the receiver.

##### - Encryption

Pay TV providers encrypt their programs at the transport stream level. Current methods include e.g. BetaCrypt, Irdeto, Viaccess, Conax, Cryptoworks, etc. A CA (conditional access) module must be integrated into the receiver for decryption to work. The module can then unscramble the transport stream again with a corresponding Smart Card.

##### - MPEG decoder

The MPEG decoder has the task of demultiplexing the transport stream and making the data available to the respective audio and video decoders. Furthermore, it ensures synchronicity between the audio and video signal.

##### - Service Information (SI)

The transport stream (TS) generally contains several programs. These programs are sent in packets one after the other. Each packet is assigned a number or PID (packet identify). The TS is managed by special tables that are part of the multiplex. The most important table is the **PAT** (program association table), which always has **PID 0**. It includes information on the number of programs contained in the multiplex.

The PAT refers to further tables, the PMTs (program map table) They contain the PIDs of the elementary streams for video and audio. With these tables the MPEG decoder can filter out an individual program in the TS and undertake MPEG-2 decoding.

#### **- Picture and sound quality**

While the transmission quality of analog TV goes hand in hand with the quality of picture and sound, the situation with digital transmission is fundamentally different.

The picture and sound quality remains unchanged over long distances, although the quality of transmission deteriorates. This is ensured by efficient error protection mechanisms which correct bit errors as they arise. Picture and sound only suddenly cut out when the reception quality is such that the corrective algorithms can no longer function (Brick Wall Effect). Shortly before that, typical "blocking" can be seen in the picture, while the sound often stops. The external error protection is identical with DVB-S, DVB-C and DVB-T (Reed-Solomon). A bit error rate of  $5^{10-3}$  with the Reed-Solomon decoder leads to this "blocking" effect. Whereas an error rate of  $2^{10-4}$  represents a virtually perfect reception.

### **8.1.2 HDTV and MPEG-4**

#### **- HDTV (High Definition TV)**

While SDTV (Standard Definition TV) such as PAL, NTSC and SECAM transmits TV pictures with a resolution of 720x576i or 720x480i as the case may be, the resolution of HDTV pictures can be up to 1920x1080p. With "i = interlaced", the pictures are transmitted with lines interlaced. With "p = progressive", the complete images are transmitted. The established HDTV resolutions are currently 1920x1080i and 1280x720p. While 1920x1080i offers a greater spatial resolution, 1280x720p offers advantages during quickly changing scenes (e.g. sports transmissions). The transmission of HDTV requires considerably higher data rates.

The development of a more efficient video compression method (MPEG-4 AVC) has led to a further reduction in data rates in comparison to MPEG-2, and has thus enabled cost-effective transmission of HDTV for the first time.

#### **- MPEG-4 AVC (Advanced Video Coding)**

MPEG-4 AVC is a highly efficient video compression standard. This is used within DVB for the digital transmission of high-resolution television (HDTV). In comparison to MPEG-2, MPEG-4 AVC leads to a further data reduction by a factor of 2-3 and improved picture quality. However, the processing necessary also increases by a factor of 3. The fundamental principle of MPEG-4 is based on MPEG-2. The details were, however, further refined and improved. MPEG-4 programs are transmitted in the DVB transport stream like MPEG-2 programs. MPEG-2 and MPEG-4 programs can thus be combined in any way and transmitted in a transport stream.

More efficient and higher quality compression methods in comparison to MPEG-1/2 Layer II are also utilized in the transmission of audio signals.

#### **- Dobby Digital AC-3 (Adaptive Transform Coder 3)**

AC-3 is increasingly used as the audio coding method with HDTV programs. Here version 5.1 offers a multi-channel sound system with 6 channels.

#### **- MPEG-2/4 AAC (Advanced Audio Coding)**

A multi-channel sound system developed by Fraunhofer IIS, similar to AC-3.

#### **- Satellite, cable and terrestrial transmission of HDTV**

Within DVB, 3 different transmission standards have been developed for satellite, cable and terrestrial transmission media. These are DVB-S, DVB-C and DVB-T. In order to further increase bandwidth efficiency, improved transmission methods have been or are being developed that stand out due to their increased efficiency in error protection (FEC = Forward error correction). DVB-S2 transmission via satellite is already in routine use. The DVB-C2 and DVB-T2 next-generation standards for cable and terrestrial respectively are still in the development phase.

## **8.2 Operation (MPEG-2 and MPEG-4 decoder)**

The following section applies to the MPEG-2 decoder as well as the MPEG-4 decoder. Any differences are explained at the appropriate point. 'MPEG-4 decoder' in the following refers to the MPEG-2/4 combination decoder.

The decoder is operated using the keypad on the device. All messages from the decoder appear on the decoder's own on-screen display.

As soon as the measuring receiver is tuned to a digital channel or digital frequency, the MPEG decoder is activated. It requires some time for its "booting procedure" which can be tracked via a progress bar. During autorange mode or analyzer mode the MPEG decoder will switch off in order to increase battery life. As a result, the "booting procedure" is repeated when the decoder is activated again.

As soon as the decoder is ready, it analyzes the transport stream present and constructs the program lists for video and audio programs and pure data services. If the decoder is unable to find a valid transport stream, a **WAITING FOR TS** message appears. In this case the corresponding digital demodulator (e.g. DVB-C) is not receiving a signal and the receiver displays an **"unlocked"** message. After the decoder has acquired the program lists from the transport stream, it displays the video program list on the OSD. If there are more than 8 video programs, the remaining entries can be found on the following pages. Use the **LEFT/RIGHT** arrow keys to scroll through the pages. If the program name is displayed as "????", this usually occurs with so-called feed channels (e.g. Premiere Fußball), which only broadcast at certain times.

An " \* " before the program name denotes an encrypted program.

By selecting **Display audio only** from the menu, the program list of audio programs is displayed. By selecting **Display data only** from the menu, all pure data services (e.g. SkyDSL) are listed separately. By selecting **Display video only** from the menu, the list of TV programmes is again made available.

```

Program properties
Name: ORF1
Prov: ORF

ServiceID:13001=32c9h
PCR  PID: 160=00a0h
VideoPID: 160=00a0h
AudioPID: 161=00a1h ger
TTX  PID: 165=00a5h

CA-System IDs
Select Audio-Stream
Start program
Back to list

```

Select a program from the list by moving the cursor onto the desired program name using the **UP/DOWN** arrow keys. Press **ENTER** once and the MPEG decoder lists the corresponding program details. The information provided is program name, program provider, service ID and the PIDs for PCR (Program Clock Reference), video, audio and Teletext (TTX). As with analog television, most program providers supply Teletext. This can be seen if a PID is entered in the place of TTX. The decoder **cannot** display any text pages. The PIDs are displayed in decimal and hexadecimal form. Some TV programs are broadcast with several audio streams. These can be various languages or a combination of MPEG and AC-3 audio streams. By choosing **Select audio stream** from the menu, the desired sound stream can be selected. Now start the selected program by pressing **ENTER**. The decoder now tries to decode the picture and sound. A message will appear accordingly if the selected program is in an encrypted format. Press the **ENTER** key again to return to the program list.

#### - MPEG-4 AV H.264 programs and MPEG-2 decoder

The MPEG-2 decoder cannot decode MPEG-4 programs. The accompanying audio streams, if transmitted in AC-3, also cannot be decoded.

These HDTV programs are however included in the program list.

In these cases a message appears under the program details reading H.264 or AC-3.

### 8.3 MPEG transport stream interface

In connection with the MPEG decoder, the device can be fitted with a transport stream interface. With this, it is possible to connect either a parallel LVDS (SPI) or a serial (ASI) interface. In both cases, there is one input as well as one output available. The LVDS interface uses the same 25-pin SubD socket for input and output. There are separate BNC sockets available for input and output with ASI.

In the default status, the transport stream interface is switched to output.

The transport stream being received via the DVB-S, DVB-S2, DVB-C and DVB-T modules is the one transmitted to the output of the interface.

The input is activated using the device's monitor function (see **Monitor function**). This allows the internal MPEG decoder to process an external transport stream. By using the **MPEG INIT** function key, the MPEG decoder analyses the transport stream and repopulates the program list.

With the ASI interface, an LED is located next to the BNC sockets. The LED flashes as soon as a valid transport stream is present at the ASI input.

Only ASI can be connected to the MPEG-4 decoder.

### 8.4 Displaying the MPEG video parameters

As soon as a live picture can be seen, the MPEG decoder displays the following parameters in a window at the bottom right of the screen.

- Profile and level: e.g. MP @ ML
- Chroma format: e.g. 4:2:0
- Video resolution: e.g. 720x576
- LetterBoxFormat: 4:3 or 16:9

Press the **LEFT/RIGHT** arrow keys at any time to show or hide the parameter window.

### 8.5 Measurement and display of the video bit rate

The decoder can measure the current bit rate of the video stream being transmitted while a live picture is played. This is shown in the [Mbit/s] field in the window described in **Displaying the MPEG video parameters**. A time window of 1s is used for measurement.

### 8.6 DVI Interface (Option in connection with MPEG-4 decoder)

The measuring device has a DVI/HDMI interface for the connection of an "HD ready" TV set. DVI stands for "Digital Visual Interface". HDMI means "High Definition Multimedia Interface". The interface is designed physically as a DVI-I socket. The protocol however conforms to HDMI. This means that, in addition to video data, audio data are also outputted. Video and audio data are transmitted via three different data channels and a differential clock line in TMDS (Transition Minimized Differential Signaling). The measuring device can be connected with the HDMI input of a TV set using a DVI/HDMI adapter. The measuring receiver does not however support HDCP (High-bandwidth Digital Content Protection). HDCP restricts the siphoning off of digital and audio material within the HDMI connection. HDCP is demanded by the program being played. If an HDTV program demands HDCP, the measuring device cannot output the data via the DVI/HDMI interface. The connected TV set remains dark in this case.

While a live picture is being displayed, the **UP/DOWN** arrow keys can be used to switch between the 1920x1080i and 1280x720p formats for the output via the DVI/HDMI interface.

### 8.7 NIT evaluation

NIT (Network Information Table) is part of the Service Information (SI) range that is transmitted in the transport stream along with video and audio programs in multiplex.

Each transport stream has a separate NIT. The NIT contains information that can be used for navigation (program search) in set-top boxes (STB).

Its exact structure is defined in EN 300 468. The NIT information depends on the reception mode chosen (DVB-S, DVB-S2, DVB-C or DVB-T).

NIT evaluation can be initiated by selecting the **NIT** menu item below the program list and then pressing **ENTER**. The OSD reports on the NIT search and the reception of individual sections in the NIT. If the entire NIT is received, the device puts together an NIT list. If the transport stream does not contain a NIT, then the search is canceled after a period of time and a relevant message appears. The NIT search can also be stopped manually by pressing **ENTER**.

The following example shows an NIT from an ASTRA transponder:

```
NIT consists of 77 items
Name:ASTRA
Network_ID: 1
Version: 29
1 12,0705 GHZ H 19,2 E
2 11,7975 GHZ H 19,2 E
3 11,7195 GHZ H 19,2 E
4 12,0315 GHZ H 19,2 E
5 12,4605 GHZ H 19,2 E
6 11,9145 GHZ H 19,2 E
7 12,1485 GHZ H 19,2 E
8 11,8755 GHZ H 19,2 E
9 11,7585 GHZ H 19,2 E
Back to list
```

In this case the NIT contains 77 entries. The network name is:

ASTRA, the network number (Network\_ID): 1, the NIT version is 29.

9 entries are displayed per page. Use the **LEFT/RIGHT** arrow keys to scroll through the entries. An entry consists of the serial number, transponder frequency, polarisation and orbital position. An " \* " after the serial number indicates that the current transport stream originates from this transponder. The yellow bar can be moved up and down with the **UP/DOWN** arrow keys. Press **ENTER** for more details on the NIT entry highlighted in yellow.

```
NIT consists of 77 items
Name:ASTRA

11 12,7215 GHZ H 19,2 E
   DVB-S2 8PSK
   SR:22000 kBd
   FEC:2/3
   TS_ID:1119=045fh
   OrgNetw_ID: 1=0001h

press ENTER to abort
```

The transport stream with the number 1119 (TS\_ID) is transmitted on a transponder frequency of 12.7215 GHz at an orbital position of 19.2° East with horizontal polarisation. Transmission occurs according to the DVB-S2 standard with 8PSK. The symbol rate is 22000 kBd, the FEC is 2/3 and the original network number (Org. Network\_ID) is 1. All IDs are displayed in decimal and hexadecimal form. Press **ENTER** to return to the NIT list. The information provided depends on the reception mode (DVB-S, DVB-S2, DVB-C or DVB-T).

If a transport stream is converted from satellite to cable, then generally the NIT in the header must be adjusted accordingly. If this is not done or only partially done, the cable box may not be able to find certain programs since the navigation is based on information provided by the NIT.

### 8.8 **Printing out the NIT (Network Information Table)**

The NIT can be printed out with the built-in printer. To do so, the NIT evaluation must first be started (see previous section).

If no NIT is found, then a printout is not possible. The NIT function key (F4) will not then display in the PRINT menu.

To start printing, press **PRINT** and then the NIT function key (F4).

### 8.9 **CI (Common Interface) to EN50221**

The device can optionally be equipped with CI slots in connection with the MPEG decoder option. CI consists of two PCMCIA slots, which can be accessed from an opening in the top of the device. These PCMCIA slots can hold up to two CAM (conditional access modules). All DVB programs can be encrypted if you have an appropriate CA module with an activated SMARTCARD. Data is encrypted only in the CA modules and not on the MPEG.

#### **Replacing CA modules:**

First, remove the plexiglass cover (1) from the top of the device using a small Phillips head screwdriver.

Lift the modules (3 and 4) and then pull them out using the eject levers (2) on the right side. You will need a pen or screwdriver to press the eject levers lightly.

---

**Important!** ⚠ To avoid damage of the PCMCIA slots please note that the **backside** of the CA moduls look to the **front** of the meter when plugged in.

---

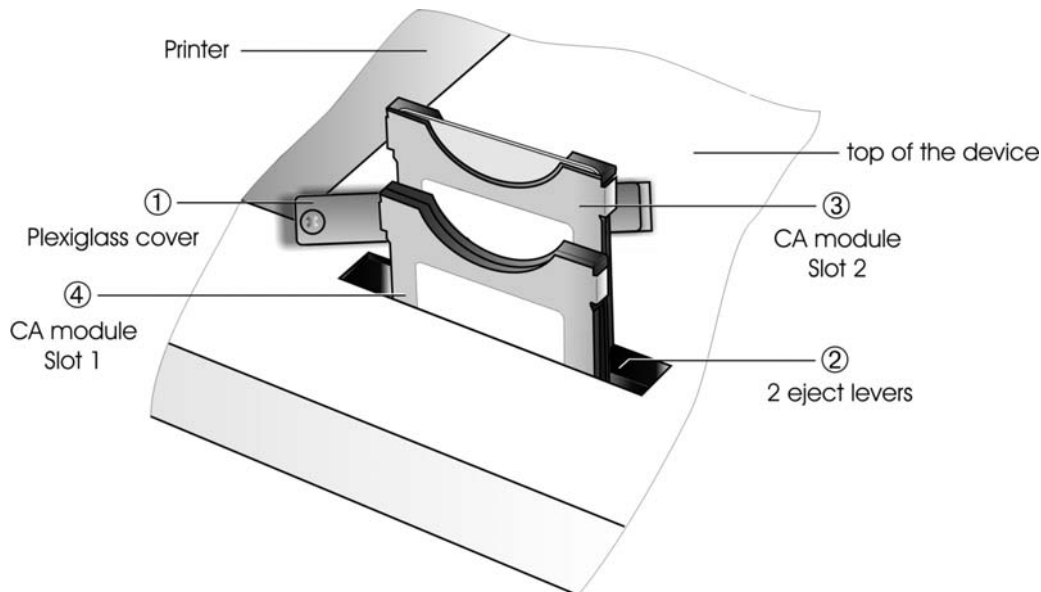

---

**Important!** ⚠ *The device must be switched off before you replace the modules!*

---

The inserted CA modules are re-initialised every time the MPEG decoder is cold started. The MPEG-2 decoder also supports the original Premiere CAMs.

As soon as the modules have been initialised, the MPEG decoder starts analysing the transport stream for PSI (program service information), after which it draws up the program list.

The inserted CA modules can be queried under the **Common Interface (CI)** menu item.

```

slot 1
Info: AlphaCrypt

Slot2
CA-System IDs
Card Menu

exit

```

The **Common Interface (CI)** menu is structured as follows:

- The first menu item enables a choice between slot 1 (first slot when viewed from the keyboard) and slot 2.
- The CA system ID's are listed when you select the **CA-SYSTEM IDs** menu item. If the list is longer than one page, the **LEFT/RIGHT** arrow keys can be used to scroll back and forth.
- The **CARD MENU** menu item allows you to access the module-specific menu. Various information and services can be accessed for each module. E.g. smartcard information, software version, software update, PIN input etc.
- The following applies for the menu interface: The **UP/DOWN** arrow keys can be used to scroll through the menu. The **LEFT/RIGHT** arrow keys can be used to scroll back and forth. Press **ENTER** to select a menu item.
- If the module requires entry of a PIN, select the number field using the **LEFT/RIGHT** arrow keys and set the relevant number (0-9) using the **UP/DOWN** arrow keys. Press **ENTER** to confirm the entry. The PIN **cannot** be entered using the number pad!

The following illustration shows the main menu of an alphacrypt module:

```

AlphaCrypt 3.11 (c) Mascom GmbH
Module Mainmenu

Information
Smartcard
Email Messages
Parental Control
Module options
Quit

exit

```

To play an encrypted program, follow the same procedure as for a non-encrypted program:

Select the program name from the station list and press **ENTER** to confirm. The list of program details appears.

```
Program properties
Name: ORF1
Prov: ORF

ServiceID:13001=32c9h
PCR PID: 160=00a0h
VideoPID: 160=00a0h
AudioPID: 161=00a1h ger
TTX PID: 165=00a5h

CA-System IDs
select Audio-Stream
Start program
Back to list
```

If the program is encrypted, the menu item **CA-System IDs** appears in the program details. All CA-System IDs for this program, with the corresponding name of the encryption system, are listed here. The list below is taken from a program with **Simulcrypt** encryption with 4 different CA-System IDs.



## Chapter 9

# Tuning Memory

---

The instrument has non-volatile tuning memory for 200 stations from any service area. The following settings can be stored:

Analog/digital mode, frequency range, transmitter frequency, sound carrier or sound carrier frequency, modulation scheme in digital mode, TV standard, channel symbol rate, video deviation and ADR frequency in the SAT range and all LNB settings including DiSEqC and UNICABLE.

You can use **special program 94** to prevent changes from being made to any memory area (see "Special Program" chapter). The procedures illustrated below require available memory.

To enable memory storage, you must first select a range and then tune to a frequency or channel. In the satellite range, you may need to activate a supply voltage and possibly a signal frequency beforehand.

### 9.1 Saving

Press **SAVE**.

If measurement data is stored in the measured value memory, an error message is displayed.

**"READ OUT AND ERASE MEASURED VALUE MEMORY FIRST!"**

The measurement data in the measured value memory are linked with the tuning memory. Because of this, the measurement data in the measured value memory can no longer be reconstructed if the tuning memory is changed. For this reason, the measurement data in the measured value memory can no longer be reconstructed if the tuning memory is changed.

Enter a memory location between 1 and 200 (appears in display immediately) and you can save a station at that location by pressing **SAVE** or **ENTER**.

If the memory position is located in the secured sector, then this storage space will not be changed !

### 9.2 Memory locations

If a memory location is not specified before saving, the station is saved in the lowest available location.

To generate **memory groups**, leave a memory location empty or erase it. An empty memory location indicates the end of a memory group.

### 9.3 Accessing memory

To access a memory location, press **RECALL**, specify a number between 1 and 200 and then confirm with **ENTER**. If the memory location is occupied, the station is set and the measurement is started. If the memory location is available, **EMPTY** appears in the display.

If you press the **STATION SEARCH** ↑ or **STATION SEARCH** ↓ keys instead of **ENTER** or **RECALL** at this point, you can use the **STATION SEARCH** keys to scroll through the memory locations.

Press any other key to exit this mode and the **STATION SEARCH** keys revert to their original function.

### 9.4 Sequence of memory positions

If no location is specified when accessing the memory, memory location 1 appears after pressing **RECALL**. Press the key again to access the next memory location.

### 9.5 Erasing a memory location

A wide variety of special programs are available to erase memory locations (see "Special Programs" chapter).

## Chapter 10

### Analyzer

The analyzer allows you to display stations in all frequency ranges according to level and frequency.

It can be used in analog (ANA) or digital mode (DIG). With the **ANA/DIG** key you can change the mode even when the analyzer is in use.

Depending on the mode, the correction values are calculated into the displayed level according to the bandwidth.

**Note:**

In **TV ranges** and in **DIG** mode, the level of digital stations with symbol rates > 6000 kBd is indicated correctly while the level of analog stations is 4dB too high (in narrow band sweep this correction is 9dB). The digital stations with symbol rates > 6000 kBd should be measured in the video mode. For this please adjust the cursor to the station and use key **VIDEO** (F1). Now the symbol rate – which was adjusted in the meter – is considered for the level measurement.

Conversely, in the **ANA** mode the level of analog stations is indicated correctly while the level of digital stations with symbol rates > 6000 kBd is 4dB too low (in narrow band sweep this correction is 9dB).

A measuring bandwidth of 8 MHz is used in the **SAT range** (at 4.3 MHz for narrow band sweep) Analog transponders are indicated correctly. **Digital** transponders with a wider bandwidth have to be corrected according to the bandwidth ratio.

$$\text{Correction level} = 10 \cdot \log_{10} \frac{\text{Transponder bandwidth}}{\text{Measurement bandwidth}} \quad \text{eg Correction level} = 10 \cdot \log_{10} \frac{36 \text{ MHz}}{8 \text{ MHz}} = 6.5 \text{ dB}$$

$$\text{Correction level} = 10 \cdot \log_{10} \frac{\text{Transponder bandwidth}}{\text{Measurement bandwidth}} \quad \text{eg Correction level} = 10 \cdot \log_{10} \frac{27 \text{ MHz}}{8 \text{ MHz}} = 5.3 \text{ dB}$$

This value must be added to the indicated level.

In video mode, the measuring instrument corrects the bandwidth automatically. To do so, position the cursor on the transponder and press the VIDEO function key (F1). In this mode, the symbol rate set in the instrument when determining the level is taken into consideration. It must be the same as the symbol rate of the selected transponder and the analyzer must work in digital mode (DIG).

The level can be determined via the dB grid that appears on the screen.

The upper and lower frequency limits are displayed in the top margin of the screen.

The frequency and corresponding level value can be displayed using the movable cursor on the screen.

**Important!**  **(This applies to TV ranges only)**

*In analog mode, the test frequency grid is set up so that the test frequencies fall exactly on the video carrier of the analog station. This allows the analog level to be measured correctly.*

*In digital mode, the test frequency grid is set up so that the test frequencies fall in the middle of the digital channels. This means analog stations in this mode may not be on the test frequency grid and the level may therefore be too low.*

*The exact test frequency can be selected and displayed using the cursor.*

Generally there are 5 different analyzer modes available that are activated directly or by selecting the relevant menu.

If a station with a high level is in the range to be displayed, the sensitivity of the instrument is automatically reduced to avoid uncontrolled mixing.

This can be seen in the display when the lowest indication range is covered or the dB scale in the left margin changes (autoranging).

A dynamic of 60dBµV in the TV range and a dynamic of 50dBµV in the SAT range can be displayed on the screen.

A scale value of 80dBµV is displayed in red for better orientation.

Press **NARROW** (F2) to switch to narrow band sweep. Incoming frequencies are displayed around the current cursor position. If the function is active, the **NARROW** key is displayed inverted.

In narrow band sweep, the analyzer display shows a frequency range of 28MHz in the TV range and a frequency range of 102MHz in the SAT range.

Press **NARROW** (F2) again to switch back to range sweeping.

The **MENU** key always leads to the analyzer main menu (see illustration in the "Starting analyzer" section below).

Press **VIDEO** (F1) to see the video at the current cursor position in the TV, return channel, and SAT-IF ranges. Press the key (F1) again to return to the analyzer display.

Press **SOUND** to hear the demodulated sound of the station at the current cursor position in the radio broadcasting range. The analyzer display will remain visible. Press the inverted **SOUND** key to return to the analyzer display with continuous level updating.

**SAT mode:** The LNB settings that have been selected and activated are displayed. These settings can be changed at any time during the analyzer display in the SAT range by pressing the **LNB** key and then making adjustments (see "LNB Supply" chapter).

If the **VIDEO** or **SOUND** modes are selected, you can adjust the frequency in the same increments as in the analyzer display by using the **FINE** ← and **TUNE** → key.

The cursor of the analyzer display is then also set to the tuned frequency.

### 10.1 Starting analyzer

When you press **ANALYZ** in standby status (status after the **RESET** key is pressed), the following operating menu is shown in the display:

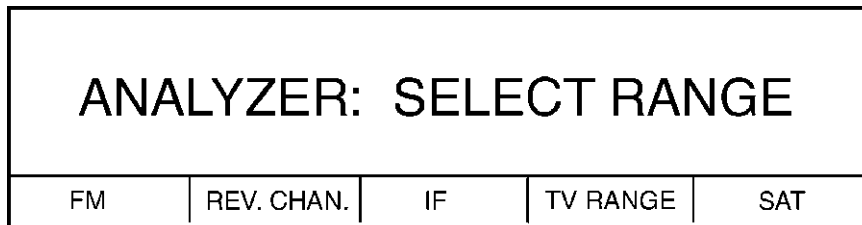

You can now select the corresponding range.

With software version xx.24a and later versions, there is another way of starting the analyzer.

The analyzer starts in narrow band sweep mode if you press **ANALYZ** when a transmitter has already been opened. The cursor is then on the frequency of the transmitter previously set. The analyzer can then be operated using the already familiar procedures.

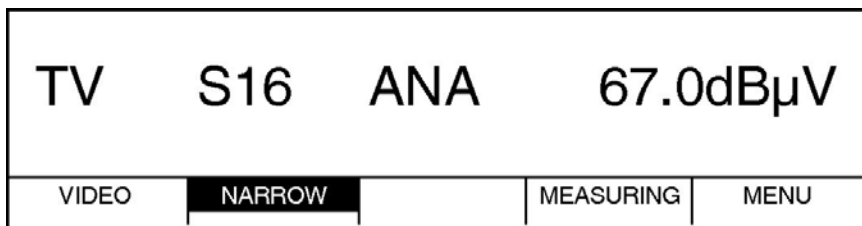

The new **MEASURING** (F4) function key allows you to switch the analyzer to individual measurement (even after the cursor has been moved). That means that all operating functions of individual measurement are available.

**10.1.1 Start the analyser in the SAT range when UNICABLE is activated.****Start, when a transmitter has been called:**

If the **ANALYZ** key is pressed when a transmitter (transponder) has already been called, the analyser starts in narrow sweep mode. The cursor then shows the frequency, as converted by the UNICABLE unit, of the previously selected transmitter. The spectrum that the UNICABLE unit outputs is displayed.

It must be ensured that the SCR address and the centre frequency of the UB slot (bandpass) correspond to those in the UNICABLE unit as used in the measuring receiver.

The analyzer can then be operated using the already familiar procedures.

If the display is changed from narrowband to broadband, it is no longer possible to go back directly to individual measuring.

It is still possible though, to see the video image of the transponder with the VIDEO key (F1).

If, while in analyser mode, the SCR address is changed via the LNB setting, a further UB slot (bandpass) is activated in the UNICABLE unit, which shows the same spectrum as the previously called UB slot. In this way, all available UB slots can be displayed in the spectrum at the same time.

If the LNB feed to the UNICABLE unit is switched off, all settings in the UNICABLE unit will be lost.

**Start from standby status:**

If the analyser is called during standby status (status after pressing the **RESET** key), the UNICABLE unit is tuned to the transponder that corresponds to the frequency of the cursor in the analyser (in LOW band:  $9,750\text{MHz} + 1525\text{MHz} = 11,275\text{MHz}$ , in HIGH band:  $10,600\text{MHz} + 1525\text{MHz} = 12,125\text{MHz}$ ). The analyser displays the spectrum of the output from the UNICABLE unit.

The spectrum of the tuned transponder is to be seen in the middle of the UB slot (bandpass).

It must be ensured that the SCR address and the centre frequency of the UB slot (bandpass) correspond to those in the UNICABLE unit as used in the measuring receiver.

The video image of the transponder can be seen with the **VIDEO** key (F1).

If, when in analyzer mode, the LNB setting is changed, the UNICABLE unit is tuned to the transponder that corresponds to the frequency of the cursor when the analyzer is switched on ( $11,275\text{MHz}$  or  $12,125\text{MHz}$ ). The spectrum of this transponder is displayed in the UB slot (bandpass).

If, while in analyser mode, the SCR address is changed via the LNB setting, a further UB slot (bandpass) is activated in the UNICABLE unit. In this way, all available UB slots can be displayed in the spectrum at the same time.

If the LNB feed to the UNICABLE unit is switched off, all settings in the UNICABLE unit will be lost.

**10.2 FM range**

The entire FM frequency spectrum is displayed and continuously updated here.

Measuring bandwidth: 200kHz

Press **SOUND** to hear the selected station. Stereo and the station name will indicated.

**10.3 Return channel range**

The entire frequency spectrum from 5 to 65MHz is displayed and continuously updated here.

Measuring bandwidth: 200kHz (delivery before April 2006: 1 MHz)  
with **NARROW** band sweep: 70kHz

A peak hold function was included in the return channel range.

This function is activated using the **PEAK HOLD1** (F3) or **PEAK HOLD2** (F4) function keys, and the corresponding key field is displayed inverted.

This records the maximum level of the received frequency range on the screen.

Only increases in the level are updated, decreases are ignored.

The holding time during measurement is longer for **PEAK HOLD2** than for **PEAK HOLD1**. This allows levels which occur less frequently to be recorded, however it makes the measurement run significantly longer.

You can switch between **PEAK HOLD1** (F3) and **PEAK HOLD2** (F4) at any time. Pressing a function key which is displayed inverted a second time deactivates the function and the key panel display returns to its normal condition.

**Notes!**  If the level scale on the left of the screen has to be updated, a new measurement run is started!

### 10.4 IF range

The entire frequency spectrum from 5 to 47MHz is displayed and continuously updated here.

Measuring bandwidth: 200kHz (delivery before April 2006: 1 MHz)  
with **NARROW** band sweep: 70kHz

### 10.5 TV range

Measuring bandwidth: 1MHz with **NARROW** band sweep: 70kHz

Press the **TV-RANGE** key (F4) and the following is displayed:

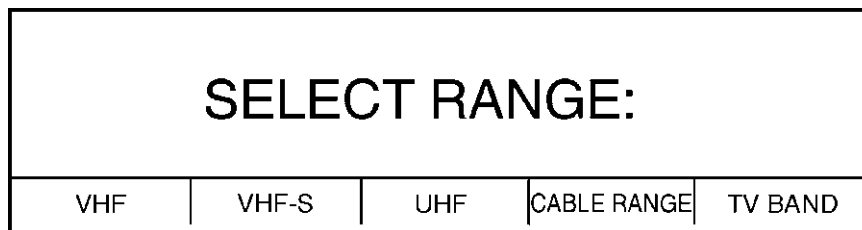

Use the relevant function keys to select the desired range.

If UHF is selected, for example, the following is displayed:

(If the frequency at the cursor is that of a channel, the channel number is displayed).

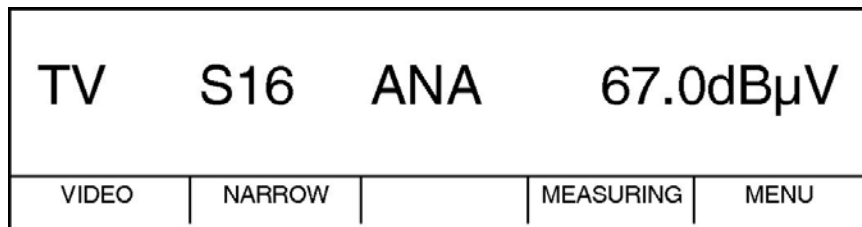

The new **MEASURING** (F4) function key allows you to switch the analyzer to individual measurement of the frequency at the cursor (even after the cursor has been moved). That means that all operating functions of individual measurement are available.

#### 10.5.1 VHF, VHF-S, UHF

The display of the VHF range (band I and III) also covers the FM range. However, the grid is not as precise as the one in the FM range display.

The values displayed on the screen are continuously updated.

#### 10.5.2 Cable range

The entire frequency range from 44.75 to 467.25MHz can be displayed in this mode. The FM range is included in this measurement.

The values displayed on the screen are continuously updated.

#### 10.5.3 TV – Complete

The entire television frequency range from 44.75 to 867.25MHz can be displayed in this mode.

The FM range is also included.

The display is continuously updated.

**Notes!**  Press **NARROW** (F2) to switch to narrow band sweep. Incoming frequencies are displayed around the current cursor position. If the function is active, the **NARROW** key (F2) is displayed inverted. You can also switch to digital channels or frequencies with the **ANA/DIG** key to use digital measuring features such as BER measurement or the MPEG decoder. In the analyzer display, this can be seen by the **DIG** indication in the top line.

## 10.6 SAT range

Measuring bandwidth: 8 MHz (delivery before April 2006: 4,3 MHz)  
with **NARROW** band sweep: 4.3 MHz

The following menu is displayed (in analog mode):

SC=7.02MHz		LNB: 14.0V		
SAT 1570 MHz ANA 67.2dBμV				
VIDEO	NARROW		MEASURING	MENU

Press **VIDEO** (F1) to see the video at the current cursor position. The audible sound corresponds to the sound subcarrier that was set before the measurement. Press the key (F1) again to return to the analyzer display.

You can also switch to digital channels or frequencies with the **ANA/DIG** key to use digital measuring features such as BER measurement or the MPEG decoder.

In the analyzer display, this can be seen by the **DIG** indication in the top line. Press **VIDEO** (F1) to activate the MPEG decoder. This makes the digital picture visible.

Press **NARROW** (F2) to switch between **narrow band sweep** and **range sweep**. The **NARROW** key (F2) is displayed inverted during narrow band sweep.

The narrow band sweep shows a range of 102MHz. This range is good for observing cross-polarization decoupling.

The new **MEASURING** (F4) function key allows you to switch the analyzer to individual measurement of the frequency at the cursor (even after the cursor has been moved). That means that all operating functions of individual measurement are available.

A new analyzer mode can be selected with the **MENU** key (F5).

The LNB settings can be changed with the **LNB** key (see "LNB Supply" chapter). The settings are shown in the display. The LNB local oscillator frequency is displayed in transponder frequency mode. In **RF autom.** mode, use **22.0kHz** (F4) to toggle the LNB local oscillation frequency between 9,750GHz and 10,600GHz.

## 10.7 Finding a frequency with the cursor

The cursor on the screen (designated by a star in the top margin) can be moved with the **FINE** ← and **TUNE** → keys.

The position of the cursor is displayed as a frequency or channel with corresponding level. The measurement is interrupted while the cursor is being moved.

The cursor can also be moved with the numeric keypad.

The tuned frequency must be with the displayed analyzer indication.

After input of a frequency and release with **ENTER**, the cursor will jump to the requested frequency.

## Chapter 11

### List of Special Programs

---

#### Controlled by MODE key

- 00 Erase all memories
- 04 Erase FM data
- 05 Erase VHF-E data
- 06 Erase VHF-S data
- 07 Erase UHF-E data
- 08 Erase one memory location
- 09 Erase satellite frequencies
  
- 11 LCD backlighting ON/OFF
- 18 Change standard
- 19 Change language of user interface
  
- 20 Automatic printout
- 21 Automatic save
  
- 35 Monitoring program **ON**
- 37 Save measured values
- 38 Printout saved values
- 39 Erase saved values
  
- 40 Display date and time
- 41 Set date and time
  
- 64 Edit protocol header
- 65 Print protocol header
  
- 70 Deactivation of the high pass filter for channel S2/S3
- 71 Deactivating/activating power-saving mode
- 72 Change detuning resolution
- 73 Switch frequency input (1. SAT-IF or RF)
- 74 Print hum
  
- 81 Selection of Sound carrier measurement (absolutely or relative)
- 82 Selection of signal bandwidths with COFDM
- 83 Measuring resolution (1 or 0.1dB)
- 84 Switch dB display size (normal/double height)
- 85 Measure current
- 87 Display setting of analog bar
- 88 Relative measurement (with C/N display capability in SAT range)
- 89 S/N measurement → switch line (optional)
  
- 90 Serial number and release code for documentation software
- 91 Battery charge display
- 94 Memory protection ON/OFF
- 96 Setting of RD-232 interface parameters
- 97 Default setting
- 98 Show software version of instrument

#### Accessible directly from keypad:

- |  |                                |
|--|--------------------------------|
| Sound carrier measurement                      | LNB remote supply              |
| Sound carrier selection in SAT range           | IF measurement                 |
| Channel or frequency input / display           | Return channel measurement     |
| Blanking interval or SCOPE function (optional) | Printer functions              |
| Teletext                                       | Monitor function               |
| Acoustic level trend bar                       | LCD background lighting ON/OFF |
| Analyzer                                       |                                |

## Chapter 12

### Special Programs

---

Press the **MODE** key and **SPECIAL PROGRAM** will appear on the screen.

Now enter the two digits of the program you want to use.

#### 12.1 Erasing tuning memory

Protected memory locations are not erased.

- a) **Entry: MODE 00**  
Erases all memory contents
- b) **Entry: MODE 04**  
Erases all FM frequencies
- c) **Entry: MODE 05**  
Erases all VHF channels
- d) **Entry: MODE 06**  
Erases all special channels
- e) **Entry: MODE 07**  
Erases all UHF channels
- f) **Entry: MODE 08**  
Erases a prespecified memory location
- g) **Entry: MODE 09**  
Erases all satellite frequencies

---

Press **ENTER** to initiate the program.

---

If measurement data is stored in the measured value memory, an error message is displayed.

**"READ OUT AND ERASE MEASURED VALUE MEMORY FIRST!"**

The measurement data in the measured value memory are linked with the tuning memory. Because of this, the measurement data in the measured value memory can longer be reconstructed if the tuning memory is changed. For this reason, the measurement data in the measured value memory can longer be reconstructed if the tuning memory is changed.

#### 12.2 Turning LCD backlighting on and off

Backlighting is off when you turn on the instrument.

**Entry: MODE 11**

The backlighting is switched on or off immediately after entering the special program number.

Since the luminous foil that lights the display has a limited service life (> 20,000 hours), use backlighting only when necessary.

The backlighting can also be turned off or on using the **LCD-BACKL.** key (F5) when the instrument is in its default status.



### 12.3 Changing the standard

This special program allows you to set the instrument to a national standard.

The channel spacing, channel-frequency table and sound conditioning are changed according to the selected standard.

#### Entry: MODE 18

Select one of the standards listed in the display.

Key (F5) will open the next level.

Either D/K (OIRT) or D/K (China) can be selected for the D/K standard.

The D/K (China) standard is displayed as D/K (C) to differentiate between the two.

The **B/G** standard is used in Central Europe.

The **B/G (Australian)** standard is the Australian version of B/G standard.

The **M/N** standard reproduces the American frequency/channel spacing.

The **I** standard is used in the United Kingdom.

The **D/K** standard is used mainly in Eastern Europe (Poland, Czech Republic, Slovakia, Hungary, etc.).

The **L** standard is used in France.

If the standard is selected with the function keys, the instrument switches over and then returns to its default status.

In the default status (VHF/UHF, VHF-S), the selected TV standard is indicated in the upper right corner of the display.

---

**Important!** ⚠ *This setting is not erased when the instrument is turned off.*

---

**Important!** ⚠ *If a station is accessed from the tuning memory, the standard may be changed for this measurement. The standard used by the instrument is indicated on the lower right next to the level trend bar.*

*Press RESET to return to the standard that was selected with this special program MODE 18.*

---

### 12.4 Changing the language

This program allows you to change the language used in the display.

English and French are available.

#### Entry: MODE 19

The activated language is displayed inverted.

---

**Important!** ⚠ *This setting is **not** erased when the instrument is turned off.*

---

### 12.5 Automatic printout

With this special program, you can trigger a search with an automatic printout of stations above a preset minimum level. This sets either the analog or digital measuring mode.

#### Entry: MODE 20

Enter this number and the following is displayed:

<b>AUTOMATIC PRINTOUT</b>				
FM	VHF-S	VHF/UHF	TV-BAND	SAT

To be safe, any set remote supply voltages are switched off for VHF and in the terrestrial TV range when switching between frequency ranges. If the remote supply voltage should remain switched on during the search, the device must be in the same range as the range being searched when in the default status (after a RESET).

A preset LNB feed is always maintained in the SAT range. The preset parameters in digital mode (e.g. modulation type, symbol rate etc.) are accepted here as in a normal search. Select the desired range and the following is displayed:



A new level can be entered using the numeric keypad. In the satellite range, this level may be between 40 and 119dBμV. In the remaining frequency ranges, the level may be between 30 and 119dBμV. Confirm the entry by pressing **ENTER**.

When a TV or SAT range has been selected, the **ANALOGOUS** (F1) or **DIGITAL** (F2) function keys can be used to define whether analog or digital stations should be searched.



If the entry is complete, the printer starts printing the protocol header showing the date and time. The instrument then begins the search in the selected frequency range. Each analog or digital station that is above the selected level value according to the settings is printed.

**12.6 Automatic storage**

This special program allows you to scan specific frequency ranges according to station and then store the results in memory. This sets either the analog or digital measuring mode. If measurement data is stored in the measured value memory, an error message is displayed.

**"READ OUT AND ERASE MEASURED VALUE MEMORY FIRST!"**

The measurement data in the measured value memory are linked with the tuning memory. Because of this, the measurement data in the measured value memory can longer be reconstructed if the tuning memory is changed. For this reason, the measurement data in the measured value memory can longer be reconstructed if the tuning memory is changed.

**Entry: MODE 21**

Enter this number and the following is displayed:



To be safe, any set remote supply voltages are switched off for VHF and in the terrestrial TV range when switching between frequency ranges. If the remote supply voltage should remain switched on during the search, then the device must be in the same range as the range being searched when in the default status (after a RESET).

A preset LNB feed is always maintained in the SAT range. The preset parameters in digital mode (e.g. modulation type, symbol rate etc.) are accepted here as in a normal search.

Select the desired frequency range and the following is displayed:



A new level can be entered using the numeric keypad.

In the satellite range, this level may be between 40 and 119dBµV. In the remaining frequency ranges, the level may be between 30 and 119dBµV. Specify the level and then press **ENTER**.

When a TV or SAT range has been selected, the **ANALOGOUS** (F1) or **DIGITAL** (F2) function keys can be used to define whether analog or digital stations should be searched.



The following menu is accessed using the **NEXT** (F5) function key or the **ENTER** key.

You are prompted with the message **ABOVE STORAGE-NO: xxx**, where xxx is the first empty memory location that is not protected.

You can accept this suggestion by pressing **ENTER** or specify any memory location between 1 and 200 and then press **ENTER**.

If the selected memory location is not empty, you will receive a **WARNING! MEMORY LOCATION OCCUPIED!** message. You now have the option of canceling the special program by pressing **RESET** and then starting over if necessary.

If you continue, the memory locations are overwritten as long as they are not protected (**special program 94**).

Using this method you can define a specific memory area for storage and limit the number of stations to be stored in advance.

Continue the program at this point and you will be prompted with **UP TO STORAGE-NO.: xxx**, where xxx is the last empty memory location that was found in the start memory location. You can accept this suggestion by pressing **ENTER** or specify any memory location between the start location and 200 and then press **ENTER**.

After making your entries, the instrument scans for relevant stations in the specified frequency range. The following menu appears after storage is complete:

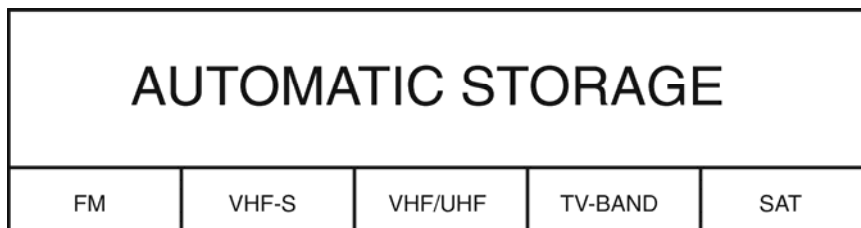

You can now enter another frequency range.

This special program provides you with a reliable overview of existing stations even if the systems are unfamiliar.

Press **RESET** to quit this special program.

### 12.7 Displaying data and time

This program displays the data and time in the instrument's integrated real time clock. The data and time are printed in the header of reports.

**Entry: MODE 40**

Enter this number and the data and time appear in the display.

Press **RESET** to return to the instrument's default status.

### 12.8 Setting data and time

With this program you can set or modify the date and time of the instrument's integrated real time clock.

**Entry: MODE 41**

Enter this number and, as an example, the following is displayed:

```
DATE:      3.11.99
ENTER DAY OR PRESS ENTER
```

Use the numeric keypad to enter the **day**. The following appears:

```
DATE:      4.11.99
ENTER MONTH OR PRESS ENTER
```

Use the numeric keypad to enter the **month**. The following appears:

```
DATE:      4.12.99
ENTER YEAR OR PRESS ENTER
```

Use the numeric keypad to enter the **YEAR**. The following appears:

```
TIME:      4:05
ENTER HOUR OR PRESS ENTER
```

Use the numeric keypad to enter the **hour**. The following appears:

```
TIME:      11:05
ENTER MINUTE OR PRESS ENTER
```

Use the numeric keypad to enter the **minute**. The following appears:

```
DATE:      3.11.99
TIME:      11:41
```

Now press **RESET** and the instrument returns to its default status.

Press **ENTER** to skip any input step if it is already correct.

### 12.9 Editing protocol header

You can customize the protocol header with this program. It can contain up to 6 lines with a maximum of 16 characters each. Fewer lines can appear in the protocol header if need be. Unused lines are not included in the printout.

**Entry: MODE 64**

Enter this number and the following is displayed:

1 : <input type="checkbox"/>	4 :
2 :	5 :
3 :	6 :
<0> : DEL	<1>. . . <6>: Select line
	<ENTER> : Act. line
CURSOR -	CURSOR +
CHAR. -	CHAR.. +
	SAVE+EXIT

You can start editing once the entry menu appears.

Use numeric keys **1** through **6** to select a line you want to edit. The cursor indicates what line is selected. Press **ENTER** to enable a line. An enabled line, which means it is to be printed out, has a **>** symbol in front of the line number.

A character can now be entered at the cursor position. Characters are selected using the **CHAR. -** (F3) and **CHAR. +** (F4) keys. The character set contains 75 unique letters and symbols.

After selecting a letter or character, use the **CURSOR -** (F1) and **CURSOR +** (F2) keys to move to the next position you want to edit.

To delete a character, press **0**.

After you have finished editing and enabling the lines according to the above instructions, press the **SAVE+EXIT** key (F5) to quit this special program.

The menu must be exited this way for the settings to be saved. If you press **RESET** to exit the **special program 64**, then the settings will **not** be saved.

### 12.10 Printing protocol header

This special program allows you to print out a protocol header.

**Entry: MODE 65**

Enter this number and the instrument will print out a protocol header. Besides the data and time of printing, the header also contains the lines that can be freely edited.

The protocol header printout can be used to generate your own protocols, for example. A value can be transferred to the printer by pressing **PRINT**.

### 12.11 Deactivation of the high pass filter for channel S2/S3

Devices that were delivered after April 2006 or devices that have been retro-fitted have a built-in switched high pass filter, in order to increase the definition of the UKW range of channel S2.

The high pass filter in the B/G standard for digital measuring in channels S1 and S2 that is automatically switched on can be deactivated using special program 70.

The filter remains deactivated until it is either activated again via this special program, or the device is switched off.

When the measured value printout is used, information on whether the high pass filter was activated or deactivated for digital measurement in channel S2/S3 is also printed.

**Entry: MODE 70**

The following message appears:

<b>FILTER FOR CHANNEL S2/S3</b>				
activated	deactiv.			EXIT

The selected setting is displayed inverted.

The filter can be deactivated or reactivated using the F2 and F1 keys.

Press the **EXIT** key (F5) to exit this special program.

When the device is switched off, it is reset to "active".

### 12.12 Deactivating/activating power-saving mode

In devices with an MPEG-4 decoder, activating power-saving mode causes the MPEG decoder to switch off after approximately 60 seconds during battery operation. This darkens the screen. If one of the cursor keys or the **ENTER** key is pressed during the 60 seconds, the time is restarted.

Power-saving mode was added because the MPEG 4 decoder consumes considerably more power, which shortens battery operating time. All measurements can still be carried out even if power-saving mode switches off the MPEG decoder.

When the device switches to power-saving mode, the following message appears in the display:

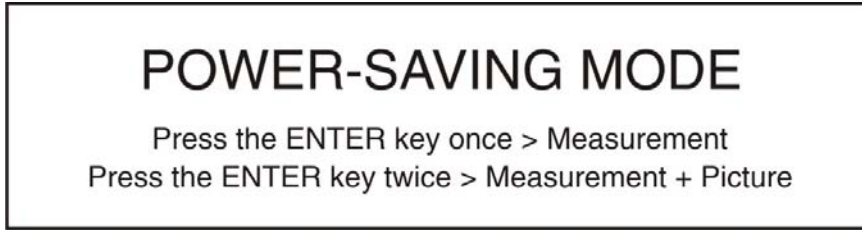

If the **ENTER** key is pressed, measurement can be carried out, but with a darkened screen. To reactivate the MPEG decoder and the screen, press the **ENTER** key again.

When power-saving mode is activated, the MPEG decoder is switched off and the screen is darkened during automatic measurement (special program 37) and automatic measurement with printout.

Special program 71 allows you to deactivate or activate power-saving mode. You can only change power-saving mode using this special program.

**Entry: MODE 71**

The following message appears:

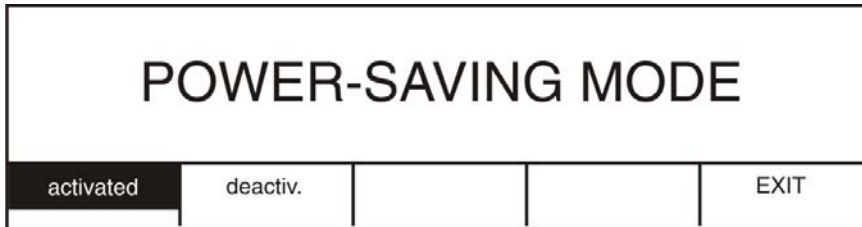

The currently selected setting is displayed inverted. The filter can be deactivated or reactivated using the F2 and F1 keys.

Press the **EXIT** key (F5) to exit this special program.

This setting is not changed when you switch the device off.

**12.13 Switching the detuning resolution (SAT)**

This programs allows you to switch detuning between 125kHz and 1MHz.

**Entry: MODE 72**

Enter **special program 72** and the detuning resolution is switched to either 1MHz or 125kHz increments. The instrument is preset to a detuning resolution of 1MHz.

**12.14 Switching the detuning input (SAT)**

The frequency input in the SAT range can be entered as a 1.SAT-IF frequency or a direct RF transponder frequency.

**Entry: MODE 73**

For more information, refer to "SAT Range" chapter.

**12.15 Activating/deactivating the hum measurement during printing**

Using this special program, the DVB-C printout of measured values during hum measurement can be activated or deactivated.

**This function is deactivated when the measuring instrument is turned on.**

**Entry : MODE 74**

HUM MEASUREMENT AT PRINT				
activated	deactiv.			EXIT

If the function is activated during a measured valued printout, the MER and BER values are first printed without hum measurements and then with hum measurements (under the "Hum measurement" heading).

If the function key **HUM** (F4) is activated in DVB-C when the constellation diagram is called up, then the measured values are printed with and without the hum measurement without considering the **special program 74** when the **PRINT** key is pressed.

### 12.16 Selection of sound carrier measurement (absolute oder relative)

This special program allows you to toggle sound carrier measurement between absolute and relative.

**Entry : MODE 81**

The following message appears:

Sound carrier measurement				
PC-SC diff	SC absol.			

The active setting is displayed inverted. The sound carrier level is displayed as the difference between the video carrier level and the sound carrier level if **PC-SC diff** is set.

If **SC absol.** is set, the absolute sound carrier level is displayed.

The setting remains even after the device is switched off.

### 12.17 Selection of signal bandwidths with COFDM

You can use this special program to switch the bandwidth selection from standard to manual. Standard is the default setting when the instrument is turned on. Signal bandwidths of 6,7 or 8 MHz can be set manually.

**Entry : MODE 82**

The following message appears:

BANDWIDTH AT COFDM				
STANDARD	8 MHz	7 MHz	6 MHz	EXIT

The active setting is displayed inverted.

In **STANDARD** mode, the signal bandwidth is set according to the bandwidth of the selected channel (e.g. 8 MHz is set for E45).

Use the relevant function keys (6, 7 or 8 MHz) to switch from standard to a fixed signal bandwidth.

The setting will remain until the instrument is switched off or another setting is selected.

The signal bandwidth used in the instrument is displayed with the modulation type, for example: COFDM7 means 7 MHz signal bandwidth.

### 12.18 Switching the measuring resolution

This programs allows you to switch measuring resolution between 1 and 0.1dB.

**Entry: MODE 83**

Select **special program 83** to display the currently set resolution.

**RESOLUTION: 1dB or RESOLUTION: 0.1 dB**

---

**Important!** ⚠ *This setting is not erased when the instrument is turned off.*

---

### 12.19 Switching the dB display size

The dB value can be displayed in normal or double size.

**Entry: MODE 84**

The display size is already switched once **special program 84** has been entered. The current selection is indicated:

dB display: **normal size** or dB display: **double size**

---

**Important!** ⚠ *This setting is not erased when the instrument is turned off.*

---

### 12.20 Setting the analog bar display

To fine tune the antenna, the resolution of the bar graph can be adjusted according to your needs.

**Entry: MODE 87**

The following message appears:



Select the **20 - 126dB** key (F1) and the bar graph covers a range of 20 to 126dBμV.

Press the **rel.w.A.rrel.** key (F2) and the analog bar has a relative range of 30dB.

Furthermore, activating this option turns on an autoranging function that restricts the analog bar graph to the centre of the screen during large level fluctuations.

Press the **rel.n.A.rrel.** key (F3) and the analog bar has a relative range of 30dB. The autoranging function is not activated in this option.

### 12.21 Relative measurement (with C/N display capability in SAT range)

This special program allows relative measurements to be carried out.

It also allows the C/N value to be displayed in the SAT range. This measurement provides information on the quality of the system.

First specify the TV channel or SAT/FM frequency and start the measurement. Activate the special program afterwards.

**Entry: MODE 88**

In relative measurement, only the level change above a reference point is measured and displayed.



The following menu appears:

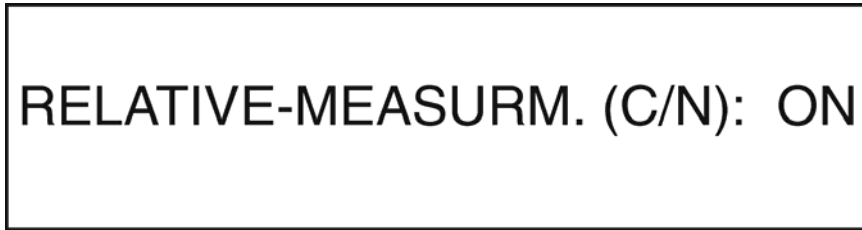

The level display is now in to the relative measurement mode. The display shows the previous operating status with a level of 0dB. The top display line also indicates that relative measurement is active.

If the level rises when setting up an antenna, for example, the display shows the difference from the level when the relative measurement was activated.

Access **special program 88** again to deactivate relative measurement.

This special program can be used in conjunction with other special programs and functions used by this instrument.

**12.22 S/N measurement → line switch (optional)**

With this special program you can select the video line to be used for S/N measurement.

**Entry: MODE 89**

The following message appears:



The active line is displayed inverted.

Use the relevant function keys to switch to another line.

The instrument resets to line 6 after being switched off.

**12.23 Serial number and release code for documentation software**

This special program allows you to either display or enter the serial number of the instrument and the release code for the documentation software.

**Entry : MODE 90**

The following message appears:

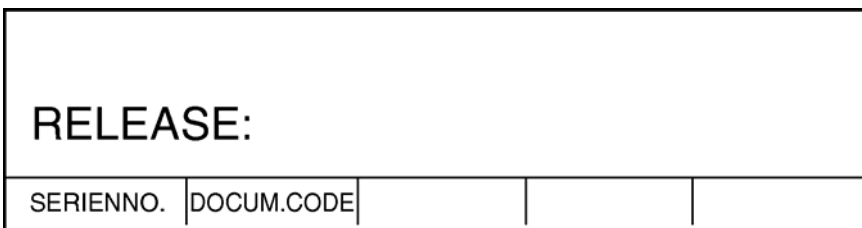

Press **SERIENNO.** F1 to display the serial number of the instrument. If 5 question marks appear instead of the number, the serial number must be specified. To avoid accidentally entering the wrong serial number, adhere to the following procedure:

1. If 5 question marks appear for the serial number, press **SAVE** three times.
2. Now enter the 5 digits of the serial number and press **ENTER**.
3. For security purposes, you are prompted to repeat the first two steps (press **SAVE** three times, enter serial number and confirm with **ENTER**).
4. The serial number is stored in memory. The following appears briefly as confirmation: **INPUT OK !**  
The serial number can no longer be changed now.

Press **DOCUM.CODE** F2 to display the release code for the documentation software. If 8 question marks appear instead of the code, the release code must be specified. To avoid accidentally changing the release code, press **SAVE** three times before entering the 8-digit release code. Press **ENTER** to complete the entry.

The following appears briefly as confirmation: **INPUT OK !**  
The release code can be changed (eg, after an incorrect entry).

Press **ENTER** to exit the special program.

### 12.24 Battery charge display

Use this special program to display data on the battery charge.

**Entry : MODE 91**

#### 12.24.1 NiMH battery operation

(Unit deliveries starting from serial number 50001)

The following message appears:

Qual.: 100 %		Power Pack charge:	
Charge current: 1500 mA		Discharge current: mA	
SET BATT			EXIT

The quality of the battery is displayed as a percentage of a new battery. When **Qual.: 100%** is displayed, 100% of the capacity of a new battery was available from the battery in the device in the last operating status.

The battery charge is displayed as a correspondingly charged battery symbol. The charge or discharge rate is displayed depending on whether the battery is being charged or discharged.

The discharge rate corresponds to the current that the instrument draws from the battery in a particular operating status.

Using **SET BATT** (F1), the charging data is manually set for a new empty battery (battery charge = 0% i.e. empty battery symbol and battery charge = 100%). This function must be confirmed twice using **ENTER** to make it effective.

---

**Important!** To ensure the charge display is accurate, a new calibration must be carried out after each battery change (see chapter "Recharging the Battery").

---

#### 12.24.2 Lead battery operation

The following message appears:

Qual.: 100 %		Power Pack charge: 95 %	
Charge current: 835 mA		Discharge current: mA	
1 BATT	2 BATT		EXIT

The quality of the battery is displayed as a percentage of a new battery. When **Qual.: 100%** is displayed, 100% of the capacity of a new battery was available from the battery in the device in the last operating status.

The battery charge is indicated as a percentage and in ampere hours. The charge or discharge rate is displayed depending on whether the battery is being charged or discharged.

The discharge rate corresponds to the current that the instrument draws from the battery in a particular operating status.

---

**Important!** ⚠ *To ensure the charge display is accurate, a new calibration must be carried out after each battery change (see chapter "Recharging the Battery").*

---

### 12.25 Displaying software version

Use this special program to display the software version of the inserted EPROM's. The software version used on your instrument is useful information when upgrading or resolving problems with the manufacturer.

**Entry: MODE 98**

The software version briefly appears on the screen.

### 12.26 Protect memory area

This special program allows you to activate or deactivate protection for any memory area.

Memory locations within a protected memory area can not be erased or modified.

**Entry: MODE 94**

This message appears briefly:

**PROTECT MEMORY AREA**

ENTRY 0 CANCELS MEMORY PROTECTION!

followed by:

**START WITH STORAGE-NO.: XXX**

The memory location **XXX** shown here can be either empty if no memory area is protected or it can be the start memory location number of a protected area. Press **ENTER** to use this setting without changes.

To change the start memory location, specify a number between 1 and 200 and then press **ENTER**.

Enter 0 for a memory location, the memory protection is canceled and confirmed by this message:

**MEM. PROTECTION CANCELED!**

Enter number between 1 and 200 for the memory location and this message appears:

UP TO MEMORY LOC. NO.: YYY

YYY is either the end memory location from a protected memory area or the start memory location from a non-protected memory area. Press **ENTER** to use this setting.

To change the end memory location, specify a number between the start memory location and 200 and then press **ENTER**.

The program confirms valid entries with this brief message:

MEM. PROTECTION NO.: XXX-YYY

XXX is the number of the start memory location and YYY is the number of the end memory location. The instrument returns to its default status afterwards.

**Important!** ⚠ The settings are **not** erased when the instrument is turned off!

### 12.27 Default setting

This special program allows you to reset the instrument to its default settings. **The tuning memory remains unchanged.**

**Entry: MODE 97**

Start the program by pressing **ENTER** twice.

Press **RESET** to cancel the program. The instrument settings are not changed if the program is canceled.

Default setting		
Range: VHF/UHF	Analog mode in terrestrial and SAT ranges	Channel input
Television standards: B/G	Colour standard: PAL	Video: non-inverted
Sound carrier I in ter. range visible and audible Difference measurement of the sound carrier level	Bar graph: entire level range	Display format of level: normal with decimal point
Station memory protection: unprotected	Frequency input mode in SAT range: RF autom.	DiSEqC: Off (position: 1)
LNB oscillating frequency LOW: 9.75GHz	Video deviation: 16MHz/V	Detuning in SAT: Off
LNB oscillating frequency HIGH: 10.6GHz	Sound carrier frequency in SAT: 7.02MHz	SCART setting: a) Scart Pin 19: Video (FBAS) b) Sound path: internal
LNB: Off (Vertical: 14.0V Horizontal: 18.0V) UNICABLE: Off RF broadband: Off	Digital settings: a) QAM64 with symbol rate of 6900kBd b) DOCSIS 64QAM symbol rate: 5057kBd c) DOCSIS 256 QAM symbol rate: 5361kBd d) QPSK symbol rate: 27500kBd	Serial interface: a) baud rate: 19200 b) 1 stop bit
LNB current measurement: Off	S/N measurement on line: 6	Language: German
LCD backlighting: Off	Time and date remain unchanged	

### 12.28 RS-232 interface

An RS-232 C-compatible interface is located on the right side of your antenna test receiver.

This interface allows you to load measured values from the instrument's internal memory to an IBM-compatible PC, remotely control the instrument from a PC, control monitoring tasks, and generate measurement protocols among other things.

To do so you may have to purchase **documentation software** and a **special interface cable** from the manufacturer.

**RS-232 Interface:**

The RS-232 C-standard defines the interface between two data terminal units for transferring serial data.

The illustration below shows the logic definition for a RS-232 C-compatible interface:

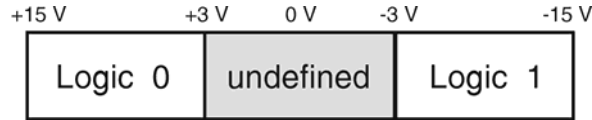

The RS-232 interface in this antenna test receiver is an asynchronous serial port for full-duplex transmissions with XON/XOFF control. The transmission levels from the hardware complies with RS-232 specifications and allow direct connection to a serial port of an IBM-compatible PC.

**Setting RS-232 interface parameters:**

With **special program 96** you can set the baud rate and the stop bit number of the antenna test receiver's interface.

**Entry: MODE 96**

The following message appears:

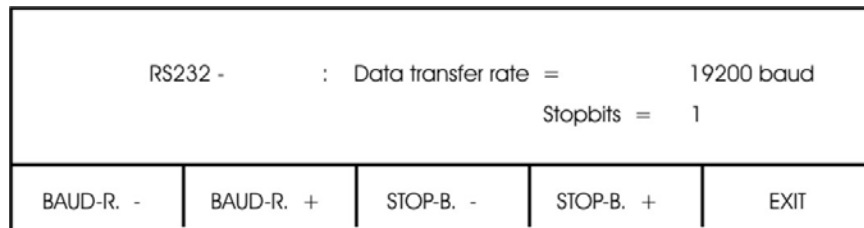

Now set the transfer rate and number of stop bits using the relevant function keys. When switching on the meter these adjustments are set to 19200 baud and 1 stopbit. The PC software is also working with these parameters.

The transfer rate can be set between 2400 and 19200 baud.

The number of stop bits is either 1 or 2.

If the interface parameters are changed, the parameters in the PC software have to be adjusted, too.

Press **EXIT** (F5) to cancel this program. The settings are stored and the interface is updated accordingly. If you exit this menu by pressing **RESET**, then the settings will not be stored in memory.

**12.29 Monitoring program**

This program enables you to monitor stations stored in the tuning memory. This can be either an individual memory location or a memory group.

The stations can be monitored for level deviation and signal quality deviation (S/N, C/N, MER and BER).

Fluctuations above or below a tolerance level that you define are recorded and printed out. The reference value (normal level) is the value measured at the start of monitoring.

**Entry: MODE 35**

This message appears briefly: **MONITORING**

You are then prompted to enter a tolerance level (tolerance window).



A value between 1 and 99dB can be entered using the numeric keypad. Press **ENTER** after you enter a tolerance level.

If the value that is measured during level monitoring falls outside of the tolerance window, a corresponding message is issued by the integrated printer.

For example, if a reference level (normal level) of 70 dBµV was determined, and you have entered a tolerance window of ± 3 dB, a message will be issued if the level that is measured falls below 67 dBµV or rises above 73 dBµV.

If you have pressed **ENTER** without entering a value, the level is not monitored. In this way, you can start a monitoring program that monitors only the signal quality.

Next, you can enter the tolerance window for S/N, C/N and MER.

TOLERANCE WINDOW:  
S/N,C/N,MER: +/- .. dB

You can use the numeric keypad to enter a value between 1 and 99 dB. If you enter a value > that 25 dB, the value of 25 dB, as it does not make sense to enter values greater than that.

Press **ENTER** after specifying the desired tolerance value.

If the value that is measured during signal quality monitoring falls outside of the tolerance window, a corresponding message is issued by the integrated printer.

For example, if you have determined a reference value of S/N = 48 dB and entered a tolerance window of ± 2 dB, a message will be issued if the S/N that is measured falls below 46 dB or rises above 50 dB.

If you have pressed **ENTER** without entering a value, the signal quality (S/N, C/N, MER and BER) is not monitored. In this way, you can start a monitoring program that monitors only the signal level.

If you have entered a tolerance value for signal quality (S/N, C/N, MER), you can now enter the tolerance value (exponential) for the bit error rate (CBER, VBER).

TOLERANCE WINDOW:  
CBER,VBER: +/- 1.0e .

You can use the numeric keypad to enter a value between 1 and 9.

Press **ENTER** after specifying the desired tolerance value.

If the value that is measured during bit error rate monitoring falls outside the tolerance window, a corresponding message is issued by the integrated printer.

For example, if you have determined a reference value of CBER = 4.0e-6 and entered a tolerance window of +/- 1.0e 2, there will be a message if the CBER that is measured rises above 4.0e-4 or falls below 4.0e-8.

Note that if the signal quality drops below the tolerance limit, the bit error rate exceeds it.

If you have pressed **ENTER** without entering a value, the default value is 9.

Now you must enter a memory location after which the monitoring function is to be active.

This function enables you to address differing memory areas. A group of memory locations that are occupied is considered a memory area. In order to separate memory groups, delete a memory location or leave one empty.

A memory group that is being monitored may contain a maximum of 50 memory locations.

START WITH STORAGE NO.: . . .

Now the printer integrated in the device issues the start date and start the time.

This starts the monitoring process. First, the stations to be monitored are called up, and the values measured on them are stored as reference values and printed out as normal level values.

Next, the stations are called up one after the other, and the values measured for them are compared with the reference values.

If the value that is measured deviates from the reference value by more than the tolerance value you have entered, the printer issues a corresponding message, with the values that were measured, the date and the time.

If the normal level returns after the deviation (a level falling within the specified tolerance range), then this is also printed out.

Here is an example of a monitoring protocol:

```

WATCH OVER

TOLERANCE WINDOW:
  LEVEL: +/- 3 dB
  S/N,C/N,MER: +/- 2 dB
  CBER,VBER: +/- 1.0e 2

START
DATE: 9.12.08
TIME: 10:00

LEVEL NORMAL
165 T S 26 D 68.5dBµV
SR 6900 kBd 256QAM
MER>38.0dB BER<1.00e-8
166 T S 28 D 62.9dBµV
SR 6900 kBd 64QAM
MER=37.1dB BER<1.00e-8

LOW LEVEL
166 T S 28 D 58.0dBµV
MER=37.5dB BER<1.00e-8
DATE: 9.12.08
TIME: 10:02

LEVEL NORMAL
166 T S 28 D 62.3dBµV
MER=37.4dB BER<1.00e-8
DATE: 9.12.08
TIME: 10:02

END
DATE: 9.12.08
TIME: 10:03

```

If the device is switched off and then back on again after the monitoring program has been activated, the monitoring program remains active. A voltage interruption of more than 2 minutes is printed out as an interruption when the device is turned back on. The printout includes the date and time.

To switch the monitoring program off, first press **RESET**, and then press **EXIT** (F1) within 7 seconds.

The **EXIT** key (F1) appears only in monitoring mode.

---

**Important!**  If you have a UNICABLE system, the monitoring program can only be used if the measuring receiver is the only receiver in that system!

---

### 12.30 Measured value storage

---

**Important!**  To ensure that this program functions properly, never change the station memory locations that were used in a measurement. If the station memory locations have been changed, the measurement values that were stored must be deleted. The measured values are linked to the station memory locations. The stored measured values are not erased when the instrument is turned off!

---

#### Storing measured values

Entry: MODE 37

STORE MEASURED VALUE

START WITH STORAGE NO.: ...

Now enter a station memory location. This and the following memory location are measured and the results are stored. Press **ENTER** after specifying the station memory location. If the specified memory location is not occupied, a **MEMORY EMPTY!** message briefly appears and you are then prompted for another memory location number.

LABEL: . . . . .

If an occupied memory location number is specified, then you are prompted for a label number. This can have between 1 and 10 digits. This label number will help you identify the memory group later. Use the numeric keypad to enter the label number.

The following selection of label numbers is offered: 10005 (example)

1 = measuring point    0005 = consecutive number of measurement

Confirm the label number entry by pressing **ENTER**.

The system now checks whether the label number has already been used. If so, the **ALREADY USED! NEW ENTRY** message appears. A new number must be entered.

This program records all the memory locations of the specified station preset until the next empty memory location is reached. The instrument now checks whether the existing memory capacity is sufficient.

If it is not, the **OUT OF MEMORY!** message appears.

The amount of memory required for each measurement is calculated as follows:

Number of required memory locations = 17 + (number of occupied station memory locations x 7)

The instrument has 24500 bytes of memory available for storing measured values.

For example: With 20 occupied station memory locations, a maximum of 156 measured value blocks can be stored.

If there is sufficient available memory, the stations are accessed, measured and stored on after the other.



The date and time is determined from the instrument's clock before the first measurement and stored as well. This lets you know exactly when a measurement was carried out (be sure the instrument's clock is set correctly → special program 41)

Press **RESET** exit the program.

**Printing measured values**

**Entry: MODE 38**

<b>PRINT STORED VALUES</b>				
AUTOMATIC	SINGLE			SEARCH

The following message appears after a few seconds:

<b>LABEL: X X X X X X X X X X</b>				
AUTOMATIC	SINGLE			SEARCH

You can scroll through the values stored in memory using the **SEARCH** key (F5). All labels found in the memory are displayed consecutively. If the label you are searching for appears, print out the corresponding series of measured values by pressing **SINGLE** (F2) or **ENTER**.

Press **AUTOMATIC** (F1) to print out all series of measured values found in the memory after the selected label.

All measured values are printed with protocol headers relisting the label number, date and time of the measurement. This helps keep printed protocols in order.

The level is printed with or without the decimal place depending on the setting of **special program 83**.

How the channel or frequency is printed out is likewise dependent on the setting in the test receiver mode.

Press **RESET** to exit the program.

Erase stored values

**Entry: MODE 39**

<b>ERASE STORED VALUES</b>				
----------------------------	--	--	--	--

You can exit this program without erasing anything by pressing **RESET**.

Press **ENTER** to continue.

ERASE ALL VALUES ?

This program erases **all** the measured values that are stored in memory. This is your last chance to press **RESET** and exit the program without erasing anything.

Press **ENTER** to finally begin erasing all values.

Upon completion, the following message appears:

ERASE DONE !

The instrument returns to its default status shortly afterwards.

### 12.31 LNB current measurement

With this program you can measure the incoming current of devices connected to the antenna input socket (eg, LNB, multi-switch, etc.).

**Entry: MODE 85**

CURRENT MEASUREMENT: ON

Now the current measurement is on. Instead of LNB voltage the LNB current in mA is indicated. To use this feature the LNB voltage must be switched on.

The current measurement is deactivated when the instrument is turned off.

Current measurement cannot be activated in analyzer mode since the measurement scan would be too slow.

Chapter 13

Printer Functions

The instrument's integrated 24-digit thermal printer allows measured values and analyzer displays to be printed out quickly.

**Note!**  Due to heat and light exposure, printouts on thermal printing paper will fade with time. Important printouts should therefore be stored with this in mind.

**Measured value printout:** (not possible in analyzer mode)

Press **PRINT** to go to the print menu. The following selection appears:

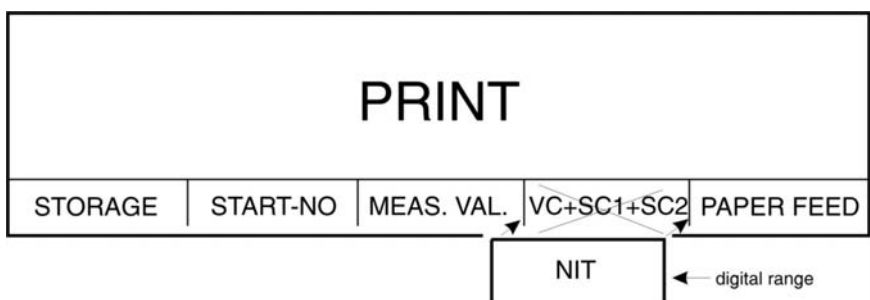

Select a print function with the appropriate key.

For a stored sound carrier measurement (SC1 or SC2), the video and audio carriers are measured and printed. SC1 → VC + SC1 SC2 → VC + SC1 + SC2

**MEMORY:** (F1) Starting from memory location number 1, the instrument measures all stations in this memory group and prints them out. An empty memory location indicates the end of the memory group.

**Printout example:** Memory locations 1 through 5 are measured and printed out.

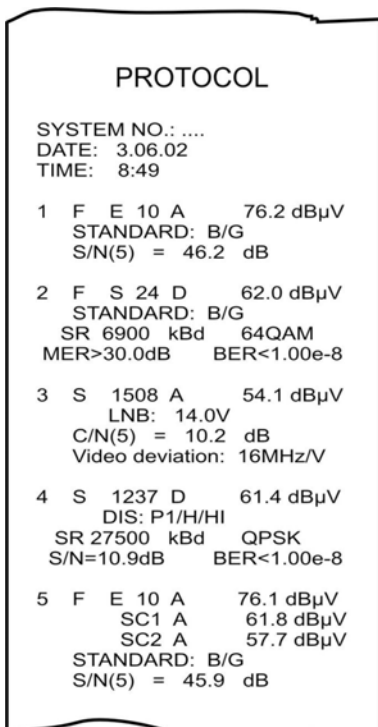

**Memory location 1:** TV range (F), channel E10, analog measurement (A), measured level, standard: B/G  
S/N measurement on line 5 (S/N(5)), S/N value (optional)

**Memory location 2:** TV range (F), channel S24, digital measurement (D), measured level, standard: B/G  
symbol rate (SR), 64QAM modulation, modulation error rate (BER), bit error rate (BER).

**Memory location 3:** SAT range (S), 1508MHz frequency, analog measurement (A), measured level, LNB supply, C/N measurement on line 5 (C/N(5)), C/N value (optional), video deviation

**Memory location 4:** SAT range (S), 1237MHz frequency, digital measurement (D), measured level, DiSEqC, satellite position (P1), horizontal polarisation (H), high band (Hi), symbol rate (SR), QPSK modulation, signal noise ratio (S/N), bit error rate (BER)

**Memory location 5:** Similar to location 1 plus sound carrier measurement (SC1 and SC2)

<b>START-NO:</b> (F2)	Press this key and you are prompted for a memory location number (memory group) on which an automatic measurement with printout is to start.
<b>MEASE. VAL.</b> (F3)	The instrument prints out the measured values of the currently selected station. For sound carrier measurement, the video carrier is printed out as well. ADR measured values are only possible using the <b>MEMORY</b> (F1) and <b>LOCK-NO</b> (F2) keys.
<b>BT+TT1+TT2:</b> (F4) (Analog range)	The meter prints out the levels of video carrier, sound carrier 1 and 2. After pressing softkey (F4) the meter expects an input of a tuning memory location. Now the meter measures from this location forward all stored memory locations. An empty location stops this procedure.
<b>NIT:</b> (F4) (Digital range)	The instrument prints out the NIT (network information table). This function is only available if an NIT is present and active. See "MPEG Decoder" chapter.
<b>PAPER FEED:</b> (F5)	The printer feeds paper until you release the key.

Press either **PRINT** or **ENTER** to exit the print menu.

If you want to print out the **channel** of a TV station, select **channel input** before accessing the printer menu. If you want to print out the frequency, select **frequency input** before accessing the printer menu. An integrated S/N module allows the S/N or C/N value in the analog range to be printed.

In the SAT range, the LNB setting values are included in the printout.

The printout in the digital range also consists of the bit error rate, the MER or S/N value and the set modulation parameters.

The screen darkens during the print job.

**Graphical printout of the analyzer display:**

First select the desired analyzer function (see "Analyzer" chapter) and wait for the display.

Now press **PRINT**. A **hardcopy** of the analyzer display is printed out.

In the TV range, the channels (or frequencies in narrow band mode) of the selected range are printed on the horizontal axis.

The Roman numerals identify the range:

I	=	VHF
II	=	special channels
III	=	UHF

In the FM, IF, return channel and SAT ranges, the frequency of the selected range is printed.

**13.1 Paper refill**

Open the printer cover by loosening the screws and pulling the lid forwards.

Insert a roll of thermal paper (see illustration below):

---

**Note!** Be sure to insert the roll as shown since the paper is only coated on one side.

---

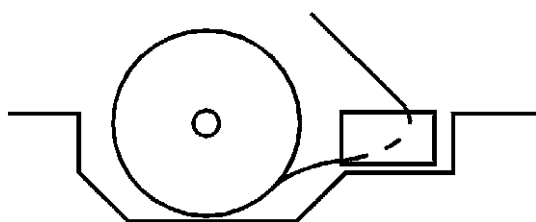

13.1.1 Manual paper feed

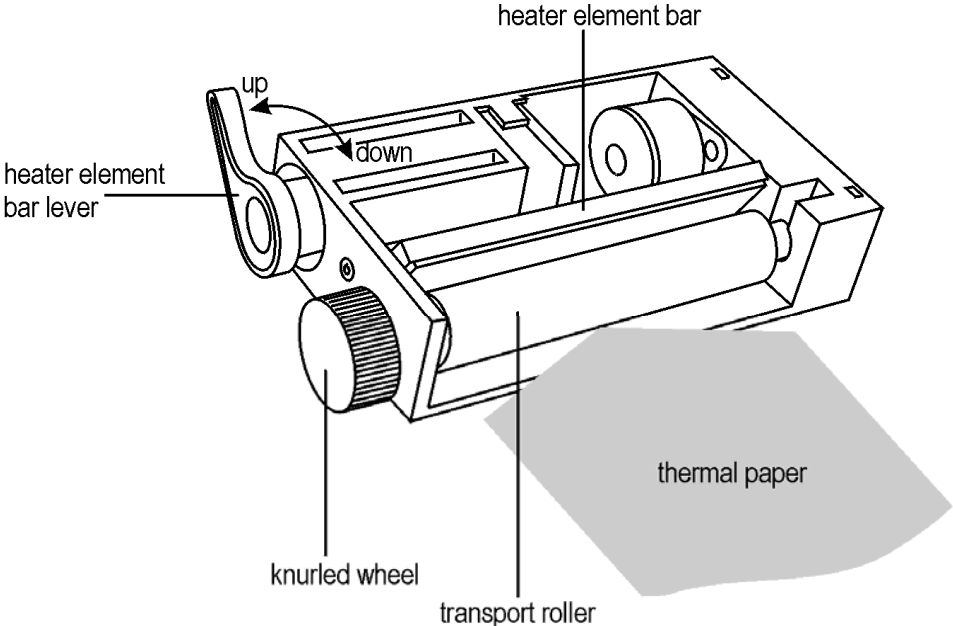

To feed in paper manually, raise the heater bar from the transport roller by pulling the lever up.

Cut the beginning of the thermal paper roll so that it is pointed (see illustration) and push it under the transport roller. Move the transport roller with the knurled wheel to help push the paper through. When the paper has been pushed through far enough press the heater bar back onto the transport roller by pushing the lever down. Guide the paper through the printer cover and replace the lid.

13.1.2 Automatic paper feed

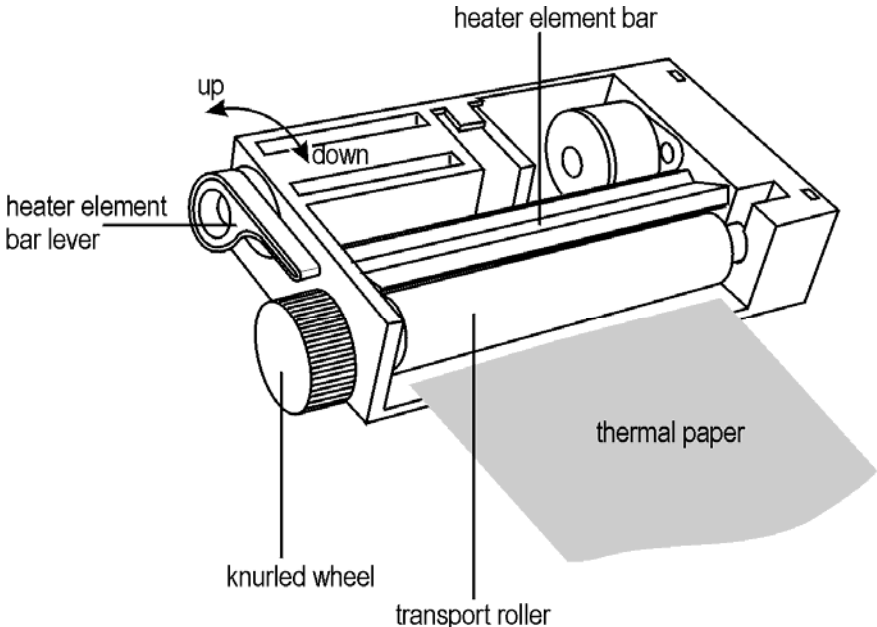

The instrument must be turned on and the heater bar must be on the transport roller (lever down).

Cut the beginning of the thermal paper roll so that it is even (see illustration) and push it under the transport roller. Once the paper sensor detects the thermal paper, the transport roller automatically turns on and moves the paper (for approx. 4cm).

If the paper is pulled in at an angle, you can lift the lever to align the paper properly. Push the lever down, guide the paper through the printer cover and close the lid.

### 13.2 **Cleaning the heating bar (only when necessary)**

The heater bar is raised from the transport roller by pulling the lever up (see illustration). Now you can clean the surface with a cloth soaked in alcohol. Push the lever down when you are done.

---

<b>Important!</b>		a) <i>Do not clean the heater bar immediately after printing – it is still hot.</i>
		b) <i>Cleaning agent: ethyl alcohol or isopropanol</i>
		c) <i>Never clean with sand paper, knives, etc.</i>
		d) <i>Wait until the alcohol has dried before printing again.</i>

---

Chapter 14

Monitor Function, SCART Parameters

The standard video signal ( $U = 1V_{pp}$  on  $75\Omega$ ) and audio signals can be output from the scart socket (Euro AV socket) on the right side of the instrument.

In addition, the analyzer display, teletext and constellation diagram are outputted as an RGB signal.

For the pin assignment of this connection socket, please refer to the diagram in the "PIN Configuration" chapter.

The instrument can also be used as a monitor by feeding a video signal into the scart socket.

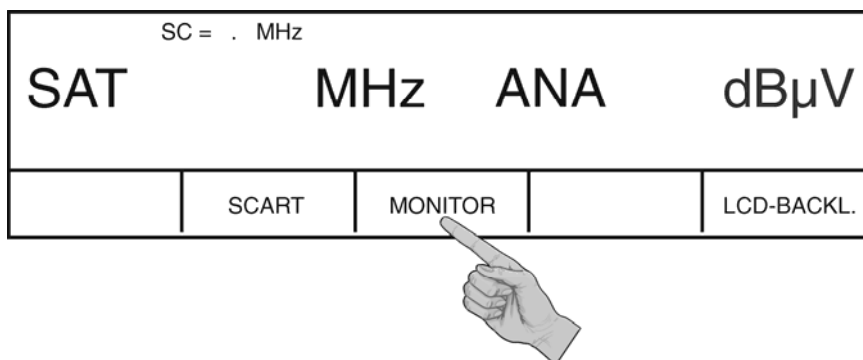

To do so, press **MONITOR** (F3) in the default mode of the instrument. The video signal fed to the scart socket is now displayed on the monitor.

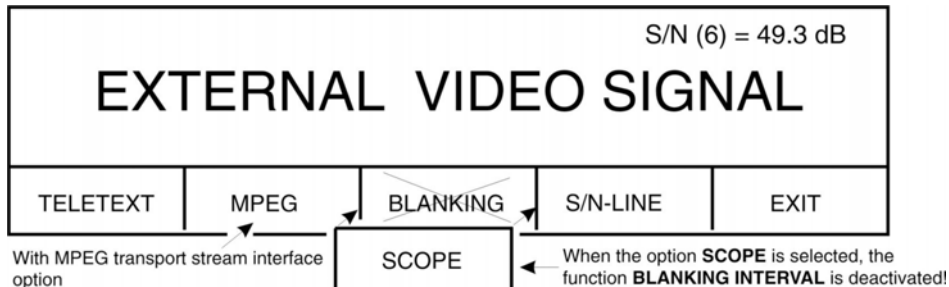

To display the teletext of the video signal, press **TELETEXT** (F1). Refer to the chapter on TELETEXT for additional teletext functions.

To switch on the blanking interval, press **BLANKING** (F3). If the function is active, the corresponding key is displayed inverted.

**Important!** If the **SCOPE** option is equipped, the **blanking interval** function is disabled.

If the optional S/N module is integrated, the S/N value of the video signal is indicated in the display. You can select lines 5, 6 or 7 using the **S/N-Line** key (F4). The selected line is displayed in brackets.

If the optional MPEG transport stream interface is installed, you can press the **MPEG** (F2) function key to switch the MPEG transport stream supplied to the interface to the MPEG decoder. You can then use all of the MPEG decoder functions. The **MPEG INIT** (F1) function key is also available. It allows you to restart the MPEG decoder if the transport stream changes, for example.

Press **EXIT** (F5) to quit the monitor function.

If a switching voltage (DC) of 12V (4.5V threshold level) enters the scart socket in TV or SAT range, a message is displayed notifying you of this and the video signal in the scart socket is switched over to the screen (the S/N value of the video signal is shown if the S/N module is available).

- see arrow

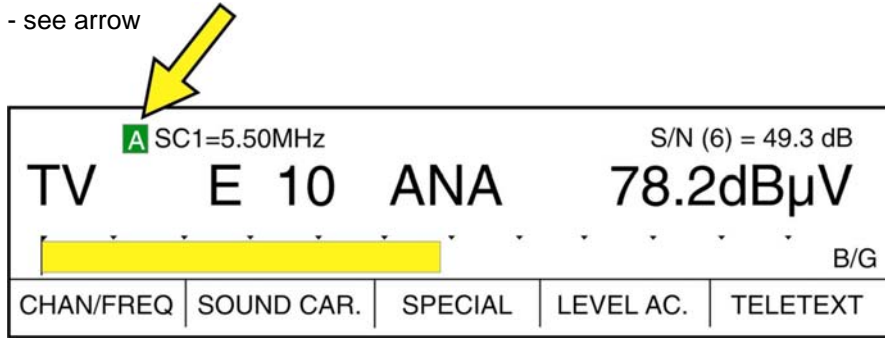

A decoder or descrambler can also be connected to the scart socket. This makes loop-in operation possible. An external monitor for picture control is not necessary.

If the output parameters of the scart socket are changed, access the **SCART** menu (F2) that is available in a number of program areas on the instrument.

For example:

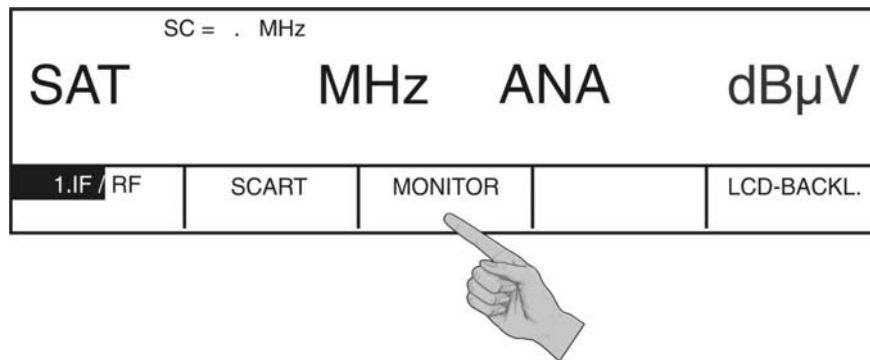

Press **SCART** (F2) and the following is displayed:

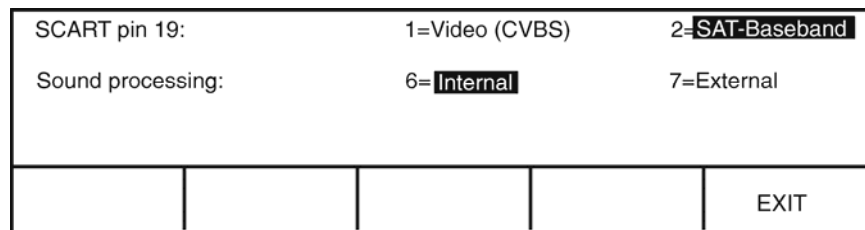

You can now set the various output parameters:

**Scart Pin 19:** The desired signal on pin 19 of the scart socket can be output here by pressing the appropriate numeric key. Select **1** to switch the CVBS signal to pin 19. Select **2** to switch the SAT baseband signal to pin 19 unclamped.

**Sound processing for decoder:** The sound processing for a connected decoder or descrambler can be set here by pressing the appropriate numeric key. Select **6** and the sound remains audible in the instrument even if the decoder or descrambler is connected. This setting is useful for encryption methods that only affect picture information. Select **7** and the external sound coming from the decoder is made audible on the instrument's loudspeaker. This requires the decoder to also have a switching voltage at the scart socket.

You can change the scart socket parameters during measurement in TV or SAT range via the **SPECIAL** (F3) menu.



## Chapter 15

### NICAM Decoder / ADR Decoder (optional)

---

#### 15.1 NICAM decoder

A NICAM decoder is available as an option for this instrument. It allows the bit error rate to be displayed. Equipped with this option, the instrument automatically detects this status from the antenna test receiver.

At present in Europe, stereo and dual-channel television sound transmissions are mostly emitted using the dual-sound technology of FM.

Although the technical requirements for this transmission method are very rigid, even the smallest discrepancy can cause considerable crosstalk between channels. This has a very negative affect on TV transmissions carrying two languages.

NICAM-728 is the official designation and stands for

**NEAR INSTANTANEOUSLY COMPANDED AUDIO MULTIPLEXING**

It has a speed of 728 kbit per second.

This transmission system was developed in Britain to eliminate crosstalk problems that can occur in conventional transmission methods. This method transmits sound using a QPSK (Quadrature Phase Shift Keying) digitally-modulated subcarrier.

NICAM-728 allows terrestrially broadcasting television companies, in accordance with PAL B/G and I, SECAM D/K or SECAM L standards, to transmit digitally-coded hi-fi stereo/dual channel sound with the quality one expects from a compact disc.

The European Broadcasting Union (**EBU**) has adopted NICAM-728 as the standard system for digital TV audio transmission. It is currently used in Belgium, Denmark, Finland, Hong Kong, New Zealand, Norway, Spain, Sweden and Great Britain. Countries such as Croatia, Macedonia, Hungary, India and Singapore, where a different standard is in use, are now considering switching over to the NICAM-728 standard.

The interval between video carrier and digital audio carrier is 5.85MHz in the B/G, D/K and L standards and 6.552MHz in the I standard.

The decoder works with all approved standards.

NICAM-728 allows the transmission of two digital audio channels. To remain compatible with existing TV audio transmission systems, NICAM-728 can also be used with an analog audio channel in a conventional transmission system.

The two digital audio channels can be used for digital stereo sound, dual-channel digital monotone and/or data transmission.

NICAM-728 operates with an alternating sampling of the left and right audio channel with a frequency of 32 kHz and a resolution of 14 bits per sampling. The resulting signal is then compressed to 10 bits for transmission. This method is called "NEAR INSTANTANEOUS COMPANDING" (NIC).

To make effective use of this method, the digital audio signals must be transmitted with a "scaling factor". This factor tells the TV audio receiver how much of the signal has been compressed.

The scale factor code is a 3-bit word. It also contains some error and security messages along with a parity bit that are transmitted with each compressed 10-bit sample.

The incoming digital signal is affected by noise when reducing the input level. Thus the bit error rate of the digital audio signal is measured in relation to the input level.

To activate the NICAM decoder, first select the TV range, desired channel or frequency and start the measurement.

Then press the **SOUND CARRIER** key.

Press **NICAM** in the new menu that appears. You can now press the **NICAM-DEM** key in the current menu.

This activates the NICAM decoder and darkens the screen.

Here is an example of what appears on the screen:

NICAM:	STANDARD: B/G	BER 1.23e -5
Status:	Stereo sound transmission	
	FM progr. mat. = NICAM progr. mat.	
	Automuting off	
		EXIT

The bit error rate is displayed in the top right corner. It is shown as an exponential value.

For example, 1.23e-5 means the bit error rate is  $1.23 \times 10^{-5}$ .

In other words, the reciprocal value of our example is 81300 and indicates that 1 false bit per 81300bits was found at the time of measurement.

---

 **A lower bit error rate means a better incoming digital signal.**

---

The incoming audio can be heard on the loud speaker.

For a dual mono transmission, you can switch to either channel using the 2 function keys. The selected channel can be heard on the loud speaker and its corresponding function key is displayed inverted.

**In addition to the bit error rate, the display shows incoming status messages:**

Decoder out of sync.

No valid digital sound-----  only data transmission on both channels

Dual mono transmission-----

Mono + Data transmission-----

Stereo sound transmission-----

Mono 1 Mono 2-----

FM progr. mat. = NICAM progr. mat. ----- conventionally transmitted sound program corresponds to the content of the NICAM program

FM progr. mat. <> NICAM progr. mat. ----- conventionally transmitted sound program does **not** correspond to the content of the NICAM program

Automuting on----- automatic muting switched on  
 a TV receiver would reset to analog sound  
 This status message is displayed inverted.

Automuting off----- automatic muting switched off

Press **EXIT** (F5) to return to the NICAM menu.  
 Here you can press **MEAS.NIC** to measure the level of the NICAM sound carrier. The screen darkens for the duration of the measurement. To switch off the NICAM sound measurement, press **MEAS.NIC** again.

You can now quit the NICAM program by pressing **EXIT** (F5) **twice**. The instrument returns to its default mode.

### 15.2 ADR decoder

Turn the instrument on and set it to SAT mode.  
 Specify an occupied transponder (eg, Bavarian TV). The following display will appear (example):

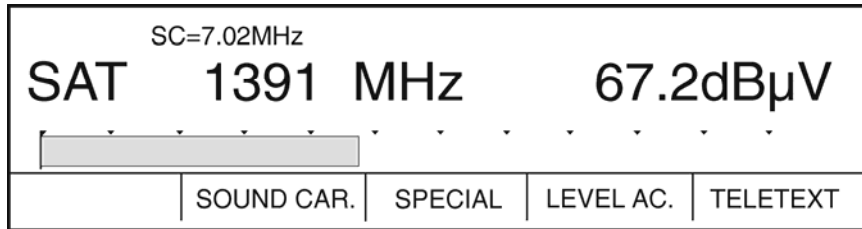

Press **SOUND CAR.** (F2) to access the sound carrier menu. The menu bar changes and the display appears as follows.

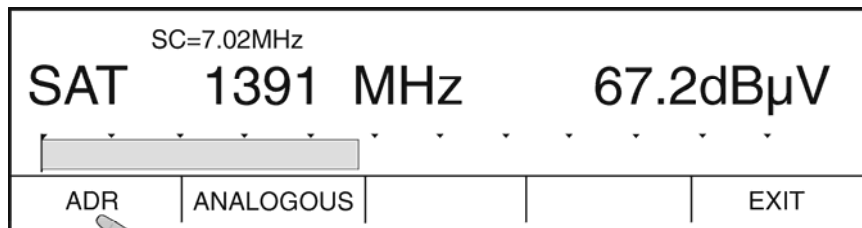

You can now press **ADR** (F1) to access the **ADR** decoder. The display will appear as:

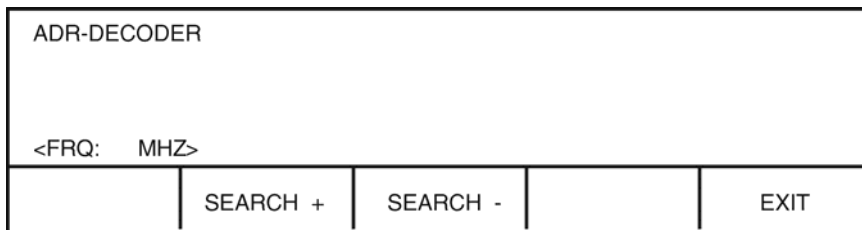

You now have the option of selecting an ADR carrier by specifying the sound carrier frequency. If the ADR carrier is available, the name of the station appears.

ADR stations that are not encrypted are audible and indicated as **FREE TO AIR** in the display.  
 DMX stations are not audible and appear in the display as **DMX**.

If an ADR carrier is not available at this frequency, **NO ADR CARRIER** appears in the display.

The following illustration shows the display after tuning to an ADR channel.

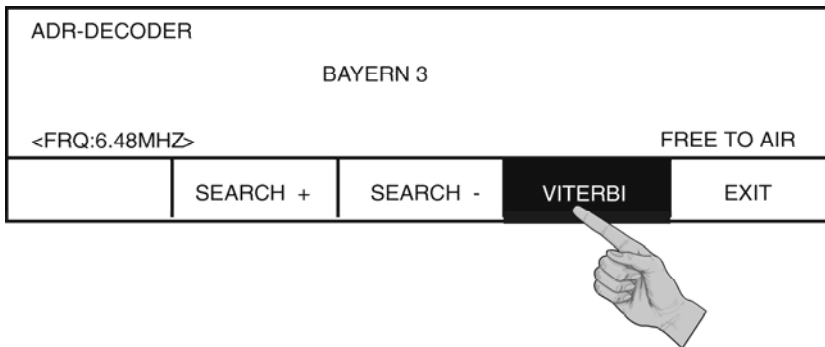
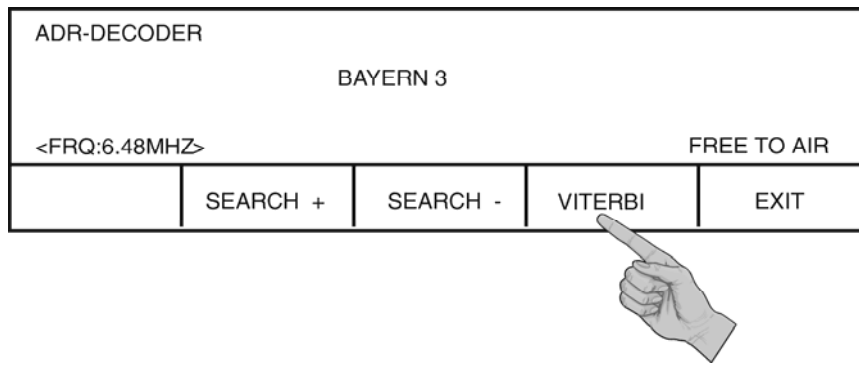

To see what sound subcarrier frequencies on a specific satellite transponder are occupied with ADR carriers, scan the satellite baseband by selecting the appropriate function key. While the instrument scans, the menu item you pressed appears inverted. Once a carrier is found, the menu item appears normal again and the display shows the name of the ADR station. You can now measure the Viterbi rate again by selecting the VITERBI menu item. You can quit the ADR decoder at any time by pressing **EXIT** (F5).

## Chapter 16

### Definition of Level

---

Definition of level according to DIN 57 855 Part 2 / VDE 0855 Part 2:

Level is the ratio of signal intensity to reference intensity expressed in dB. If the signal intensities are measured with the same resistance ( $Z = 75\Omega$ ), the level can also be the ratio of voltage to intensity expressed dB.

All levels in dB ( $\mu\text{V}$ ) used in these specifications are based on the level 0dB ( $\mu\text{V}$ ) corresponding to a signal intensity generated by a voltage of  $1\mu\text{V}$  at  $75\Omega$

#### In simpler terms:

The level in dB indicates how much the voltage or intensity value is above or below the reference value.

These reference values are predetermined for antenna and satellite measurements. This is why they are referred to as absolute levels.

When comparing intensities or voltages at any two points of a transmission system, one refers to the results as relative levels. Similarly, level changes following a trend are relative levels.

$$1\mu\text{V an } 75\Omega = 0\text{dB}\mu\text{V}$$

Table of absolute levels and their corresponding voltages:

L = level

U = voltage

L in dB $\mu\text{V}$	U in mV	L in dB $\mu\text{V}$	U in mV	L in dB $\mu\text{V}$	U in mV	L in dB $\mu\text{V}$	U in mV
40	0.10	65	1.8	90	32	115	562
41	0.11	66	2.0	91	36	116	631
42	0.13	67	2.2	92	40	117	708
43	0.14	68	2.5	93	45	118	794
44	0.16	69	2.8	94	50	119	891
45	0.18	70	3.2	95	56	120	1000
46	0.20	71	3.6	96	63	121	1122
47	0.22	72	4.0	97	71	122	1259
48	0.25	73	4.5	98	79	123	1413
49	0.28	74	5.0	99	89	124	1585
50	0.32	75	5.6	100	100	125	1778
51	0.36	76	6.0	101	112	126	2000
52	0.40	77	7.0	102	126	127	2239
53	0.45	78	8.0	103	141	128	2512
54	0.50	79	9.0	104	158	129	2818
55	0.56	80	10	105	178	130	3162
56	0.63	81	11	106	200		
57	0.71	82	13	107	224		
58	0.79	83	14	108	251		
59	0.89	84	16	109	281		
60	1.0	85	18	110	316		
61	1.1	86	20	111	355		
62	1.3	87	22	112	398		
63	1.4	88	25	113	447		
64	1.6	89	28	114	501		

Chapter 17

List of TV Channels

17.1 B/G standard

Range	Channel	Video Carrier in MHz	Sound Carrier in MHz	Range	Channel	Video Carrier in MHz	Sound Carrier in MHz
I	2	48.25	53.75	IV	21	471.25	476.75
	3	55.25	60.75		22	479.25	484.75
	4	62.25	67.75		23	487.25	492.75
USB	S1	105.25	110.75		24	495.25	500.75
	S2**	112.25	117.75		25	503.25	508.75
	S3**	119.25	124.75		26	511.25	516.75
	S4**	126.25	131.75		27	519.25	524.75
	S5	133.25	138.75		28	527.25	532.75
	S6	140.25	145.75		29	535.25	540.75
	S7	147.25	152.75		30	543.25	548.75
	S8	154.25	159.75	31	551.25	556.75	
	S9	161.25	166.75	32	559.25	564.75	
	S10	168.25	173.75	33	567.25	572.75	
III	5	175.25	180.75	34	575.25	580.75	
	6	182.25	187.75	35	583.25	588.75	
	7	189.25	194.75	36	591.25	596.75	
	8	196.25	201.75	37	599.25	604.75	
	9	203.25	208.75	V	38	607.25	612.75
	10	210.25	215.75		39	615.25	620.75
	11	217.25	222.75		40	623.25	628.75
12	224.25	229.75	41		631.25	636.75	
OSB	S11	231.25	236.75		42	639.25	644.75
	S12	238.25	243.75		43	647.25	652.75
	S13	245.25	250.75		44	655.25	660.75
	S14	252.25	257.75		45	663.25	668.75
	S15	259.25	264.75		46	671.25	676.75
	S16	266.25	271.75		47	679.25	684.75
	S17	273.25	278.75		48	687.25	692.75
	S18	280.25	285.75		49	695.25	700.75
	S19	287.25	292.75		50	703.25	708.75
	S20	294.25	299.75	51	711.25	716.75	
ESR	S21	303.25	308.75	52	719.25	724.75	
	S22	311.25	316.75	53	727.25	732.75	
	S23	319.25	324.75	54	735.25	740.75	
	S24	327.25	332.75	55	743.25	748.75	
	S25	335.25	340.75	56	751.25	756.75	
	S26	343.25	348.75	57	759.25	764.75	
	S27	351.25	356.75	58	767.25	772.75	
	S28	359.25	364.75	59	775.25	780.75	
	S29	367.25	372.75	60	783.25	788.75	
	S30	375.25	380.75	61	791.25	796.75	
	S31	383.25	388.75	62	799.25	804.75	
	S32	391.25	396.75	63	807.25	812.75	
	S33	399.25	404.75	64	815.25	820.75	
	S34	407.25	412.75	65	823.25	828.75	
	S35	415.25	420.75	66	831.25	836.75	
	S36	423.25	428.75	67	839.25	844.75	
	S37	431.25	436.75	68	847.25	852.75	
	S38	439.25	444.75	69	855.25	860.75	
	S39	447.25	452.75	70	863.25	868.75	
	S40	455.25	460.75				
	S41	463.25	468.75				

\*\*) Centre frequency in the digital range: S2 = 113MHz, S3 = 121MHz and S4 = 130 MHz

## 17.2 B/G standard (Australien)

Range	Channel	Video Carrier in MHz	Sound Carrier in MHz	Channel Middel Frequency for DVB	Range	Channel	Video Carrier in MHz	Sound Carrier in MHz	Channel Middel Frequency for DVB	
I	E0	46.25	51.75	48.50	IV	E21	478.25	483.75	480.50	
	E1	57.25	62.75	59.50		E22	485.25	490.75	487.50	
	E2	64.25	69.75	66.50		E23	492.25	497.75	494.50	
II	E3	86.25	91.75	88.50		E24	499.25	504.75	501.50	
	E4	95.25	100.75	97.50		E25	506.25	511.75	508.50	
	E5	102.25	107.75	104.50		E26	513.25	518.75	515.50	
	E5a (95)	138.25	143.75	140.50		E27	520.25	525.75	522.50	
USB Mid-band	S3	119.25	124.75	121.50		E28	527.25	532.75	529.50	
	S4	126.25	131.75	128.50		E29	534.25	539.75	536.50	
	S5	133.25	138.75	135.50		E30	541.25	546.75	543.50	
	S6	140.25	145.75	142.50	E31	548.25	553.75	550.50		
	S7	147.25	152.75	149.50	E32	555.25	560.75	557.50		
	S8	154.25	159.75	156.50	E33	562.25	567.75	564.50		
	S9	161.25	166.75	163.50	E34	569.25	574.75	571.50		
III	S10	168.25	173.75	170.50	E35	576.25	581.75	578.50		
	E6	175.25	180.75	177.50	V	E36	583.25	588.75	585.50	
	E7	182.25	187.75	184.50		E37	590.25	595.75	592.50	
	E8	189.25	194.75	191.50		E38	597.25	602.75	599.50	
	E9	196.25	201.75	198.50		E39	604.25	609.75	606.50	
	E10	209.25	214.75	211.50		E40	611.25	616.75	613.50	
	E11	216.25	221.75	218.50		E41	618.25	623.75	620.50	
	E12	224.25	229.75	226.50		E42	625.25	630.75	627.50	
	Hyper-band	S11	231.25	236.75		233.50	E43	632.25	637.75	634.50
		S12	238.25	243.75		240.50	E44	639.25	644.75	641.50
		S13	245.25	250.75		247.50	E45	646.25	651.75	648.50
		S14	252.25	257.75		254.50	E46	653.25	658.75	655.50
S15		259.25	264.75	261.50		E47	660.25	665.75	662.50	
S16		266.25	271.75	268.50		E48	667.25	672.75	669.50	
S17		273.25	278.75	275.50		E49	674.25	679.75	676.50	
S18		280.25	285.75	282.50		E50	681.25	686.75	683.50	
S19		287.25	292.75	289.50		E51	688.25	693.75	690.50	
S20		294.25	299.75	296.50		E52	695.25	700.75	697.50	
S21		303.25	308.75	305.50		E53	702.25	707.75	704.50	
S22		310.25	315.75	312.50		E54	709.25	714.75	711.50	
S23		317.25	322.75	319.50		E55	716.25	721.75	718.50	
S24		324.25	329.75	326.50	E56	723.25	728.75	725.50		
S25		331.25	336.75	333.50	E57	730.25	735.75	732.50		
S26		338.25	343.75	340.50	E58	737.25	742.75	739.50		
S27		345.25	350.75	347.50	E59	744.25	749.75	746.50		
S28		352.25	357.75	354.50	E60	751.25	756.75	753.50		
S29		359.25	364.75	361.50	E61	758.25	763.75	760.50		
S30		366.25	371.75	368.50	E62	765.25	770.75	767.50		
S31		373.25	378.75	375.50	E63	772.25	777.75	774.50		
S32		380.25	385.75	382.50	E64	779.25	784.75	781.50		
S33		387.25	392.75	389.50	E65	786.25	791.75	788.50		
S34		394.25	399.75	396.50	E66	793.25	798.75	795.50		
S35		401.25	406.75	403.50	E67	800.25	805.75	803.50		
S36		408.25	413.75	410.50	E68	807.25	812.75	809.50		
S37		415.25	420.75	417.50	E69	814.25	819.75	816.50		
S38		422.25	427.75	424.50	E70	821.25	826.75	823.50		
S39	429.25	434.75	431.50	E71	828.25	833.75	830.50			
S40	436.25	441.75	438.50	E72	835.25	840.75	837.50			
S41	443.25	448.75	445.50	E73	842.25	847.75	844.50			
					E74	849.25	854.75	851.50		
					E75	856.25	861.75	858.50		

17.3 D/K standard (OIRT)

Range	Channel	Video Carrier in MHz	Sound Carrier in MHz	Range	Channel	Video Carrier in MHz	Sound Carrier in MHz
I	RI	=1	49.75	IV	21	471.25	477.75
	RII	=2	59.25		22	479.25	485.75
	RIII	=3	77.25		23	487.25	493.75
II	RIV	=4	85.25		24	495.25	501.75
	RV	=5	93.25		25	503.25	509.75
USB	S1	111.25	117.75		26	511.25	517.75
	S2	119.25	125.75		27	519.25	525.75
	S3	127.25	133.75		28	527.25	533.75
	S4	135.25	141.75		29	535.25	541.75
	S5	143.25	149.75		30	543.25	549.75
	S6	151.25	157.75	31	551.25	557.75	
	S7	159.25	165.75	32	559.25	565.75	
	S8	167.25	173.75	33	567.25	573.75	
III	RVII	=6	175.25	34	575.25	581.75	
	RVIII	=7	183.25	35	583.25	589.75	
	RX	=8	191.25	36	591.25	597.75	
	RXI	=9	199.25	37	599.25	605.75	
	RXII	=10	207.25	V	38	607.25	613.75
	RXIII	=11	215.25		39	615.25	621.75
RXIV	=12	223.25	40		623.25	629.75	
OSB	S9	231.25	237.75		41	631.25	637.75
	S10	239.25	245.75		42	639.25	645.75
	S11	247.25	253.75		43	647.25	653.75
	S12	255.25	261.75		44	655.25	661.75
	S13	263.25	269.75		45	663.25	669.75
	S14	271.25	277.75		46	671.25	677.75
	S15	279.25	285.75		47	679.25	685.75
	S16	287.25	293.75	48	687.25	693.75	
	S17	295.25	301.75	49	695.25	701.75	
	S18	303.25	309.75	50	703.25	709.75	
	S19	311.25	317.75	51	711.25	717.75	
	S20	319.25	325.75	52	719.25	725.75	
	S21	327.25	333.75	53	727.25	733.75	
	S22	335.25	341.75	54	735.25	741.75	
	S23	343.25	349.75	55	743.25	749.75	
	S24	351.25	357.75	56	751.25	757.75	
	S25	359.25	365.75	57	759.25	765.75	
	S26	367.25	373.75	58	767.25	773.75	
	S27	375.25	381.75	59	775.25	781.75	
	S28	383.25	389.75	60	783.25	789.75	
	S29	391.25	397.75	61	791.25	797.75	
	S30	399.25	405.75	62	799.25	805.75	
	S31	407.25	413.75	63	807.25	813.75	
	S32	415.25	421.75	64	815.25	821.75	
	S33	423.25	429.75	65	823.25	829.75	
	S34	431.25	437.75	66	831.25	837.75	
	S35	439.25	445.75	67	839.25	845.75	
	S36	447.25	453.75	68	847.25	853.75	
	S37	455.25	461.75	69	855.25	861.75	
	S38	463.25	469.75	70	863.25	869.75	



## 17.4 D/K standard (China PAL)

Range	Channel	Video Carrier in MHz	Sound Carrier in MHz	Range	Channel	Video Carrier in MHz	Sound Carrier in MHz
I	1	49.75	56.25	IV	13	471.25	477.75
	2	57.75	64.25		14	479.25	485.75
	3	65.75	72.25		15	487.25	493.75
	4	77.25	83.75		16	495.25	501.75
	5	85.25	91.75		17	503.25	509.75
USB	S1	112.25	118.75		18	511.25	517.75
	S2	120.25	126.75		19	519.25	525.75
	S3	128.25	134.75		20	527.25	533.75
	S4	136.25	142.75		21	535.25	541.75
	S5	144.25	150.75		22	543.25	549.75
	S6	152.25	158.75		23	551.25	557.75
	S7	160.25	166.75		24	559.25	565.75
III	6	168.25	174.75		91	567.25	573.75
	7	176.25	182.75		92	575.25	581.75
	8	184.25	190.75		93	583.25	589.75
	9	192.25	198.75		94	591.25	597.75
	10	200.25	206.75		95	599.25	605.75
	11	208.25	214.75		V	25	607.25
12	216.25	222.75	26			615.25	621.75
OSB	S8	224.25	230.75	27		623.25	629.75
	S9	232.25	238.75	28		631.25	637.75
	S10	240.25	246.75	29		639.25	645.75
	S11	248.25	254.75	30		647.25	653.75
	S12	256.25	262.75	31		655.25	661.75
	S13	264.25	270.75	32		663.25	669.75
	S14	272.25	278.75	33		671.25	677.75
	S15	280.25	286.75	34		679.25	685.75
	S16	288.25	294.75	35		687.25	693.75
	S17	296.25	302.75	36		695.25	701.75
	S18	304.25	310.75	37		703.25	709.75
	S19	312.25	318.75	38		711.25	717.75
	S20	320.25	326.75	39		719.25	725.75
	S21	328.25	334.75	40		727.25	733.75
	S22	336.25	342.75	41		735.25	741.75
	S23	344.25	350.75	42	743.25	749.75	
	S24	352.25	358.75	43	751.25	757.75	
	S25	360.25	366.75	44	759.25	765.75	
	S26	368.25	374.75	45	767.25	773.75	
	S27	376.25	382.75	46	775.25	781.75	
	S28	384.25	390.75	47	783.25	789.75	
	S29	392.25	398.75	48	791.25	797.75	
	S30	400.25	406.75	49	799.25	805.75	
	S31	408.25	414.75	50	807.25	813.75	
	S32	416.25	422.75	51	815.25	821.75	
	S33	424.25	430.75	52	823.25	829.75	
	S34	432.25	438.75	53	831.25	837.75	
	S35	440.25	446.75	54	839.25	845.75	
	S36	448.25	454.75	55	847.25	853.75	
S37	456.25	462.75	56	855.25	861.75		
				57	863.25	869.75	

**17.5 M/N standard**

Range	Channel	Channel indicated	Video Carrier in MHz	Sound Carrier in MHz	Range	Channel I	Channel indicated	Video Carrier in MHz	Sound Carrier in MHz	
I	A02	E2	55.25	59.75		MM	S41	373.25	377.75	
	A03	E3	61.25	65.75		NN	S42	379.25	383.75	
	A04	E4	67.25	71.75		OO	S43	385.25	389.75	
	A05	E5	77.25	81.75		PP	S44	391.25	395.75	
	A06	E6	83.25	87.75		QQ	S45	397.25	401.75	
						RR	S46	403.25	407.75	
		A-5	S1	91.25		95.75	SS	S47	409.25	413.75
		A-4	S2	97.25		101.75	TT	S48	415.25	419.75
		A-3	S3	103.25		107.75	UU	S49	421.25	425.75
		A-2	S4	109.25		113.75	VV	S50	427.25	431.75
	A-1	S5	115.25	119.75	WW	S51	433.25	437.75		
USB	A	S6	121.25	125.75	AAA	S52	439.25	443.75		
	B	S7	127.25	131.75	BBB	S53	445.25	449.75		
	C	S8	133.25	137.75	CCC	S54	451.25	455.75		
	D	S9	139.25	143.75	DDD	S55	457.25	461.75		
	E	S10	145.25	149.75	EEE	S56	463.25	467.75		
	F	S11	151.25	155.75	IV	A14	E14	469.25	473.75	
	G	S12	157.25	161.75		A15	E15	475.25	479.75	
	H	S13	163.25	167.75		A16 (E16) to A67 (E67) continuous 6 MHz channel spacing 4.5 MHz video-sound carrier interval				
	I	S14	169.25	173.75		A68	E68	793.25	797.75	
III	A07	E7	175.25	179.75	A69	E69	799.25	803.75		
	A08	E8	181.25	185.75						
	A09	E9	187.25	191.75						
	A10	E10	193.25	197.75						
	A11	E11	199.25	203.75						
	A12	E12	205.25	209.75						
	A13	E13	211.25	215.75						
OSB	J	S15	217.25	221.75						
	K	S16	223.25	227.75						
	L	S17	229.25	233.75						
	M	S18	235.25	239.75						
	N	S19	241.25	245.75						
	O	S20	247.25	251.75						
	P	S21	253.25	257.75						
	Q	S22	259.25	263.75						
	R	S23	265.25	269.75						
	S	S24	271.25	275.75						
	T	S25	277.25	281.75						
	U	S26	283.25	287.75						
	V	S27	289.25	293.75						
	W	S28	295.25	299.75						
	AA	S29	301.25	305.75						
	BB	S30	307.25	311.75						
	CC	S31	313.25	317.75						
	DD	S32	319.25	323.75						
	EE	S33	325.25	329.75						
	FF	S34	331.25	335.75						
GG	S35	337.25	341.75							
HH	S36	343.25	347.75							
II	S37	349.25	353.75							
JJ	S38	355.25	359.75							
KK	S39	361.25	365.75							
LL	S40	367.25	371.75							

## 17.6 L standard

Range	Channel	Video Carrier in MHz	Sound Carrier in MHz	Range	Channel	Video Carrier in MHz	Sound Carrier in MHz
<b>I</b>	A=91	47.75	41.25*	<b>IV</b>	21	471.25	477.75
	B=92	55.75	49.25*		22	479.25	485.75
	C=94	63.75	57.25*		23	487.25	493.75
	C1=93	60.50	54.00*		24	495.25	501.75
<b>USB</b>	S1	120.75	127.25		25	503.25	509.75
	S2	128.75	135.25		26	511.25	517.75
	S3	136.75	143.25		27	519.25	525.75
	S4	144.75	151.25		28	527.25	533.75
	S5	152.75	159.25		29	535.25	541.75
	S6	160.75	167.25		30	543.25	549.75
	S7	168.75	175.25		31	551.25	557.75
	1	176.00	182.50		32	559.25	565.75
	2	184.00	190.50		33	567.25	573.75
	3	192.00	198.50		34	575.25	581.75
	4	200.00	206.50		35	583.25	589.75
	5	208.00	214.50		36	591.25	597.75
	6	216.00	222.50		37	599.25	605.75
<b>OSB</b>	S14	224.75	231.25	<b>V</b>	38	607.25	613.75
	S15	232.75	239.25		39	615.25	621.75
	S16	240.75	247.25		40	623.25	629.75
	S17	248.75	255.25		41	631.25	637.75
	S18	256.75	263.25		42	639.25	645.75
	S19	264.75	271.25		43	647.25	653.75
	S20	272.75	279.25		44	655.25	661.75
	S21	280.75	287.25		45	663.25	669.75
	S22	288.75	295.25		46	671.25	677.75
	S23	296.75	303.25		47	679.25	685.75
	S24	303.25	309.75		48	687.25	693.75
	S25	311.25	317.75		49	695.25	701.75
	S26	319.25	325.75		50	703.25	709.75
	S27	327.25	333.75		51	711.25	717.75
	S28	335.25	341.75		52	719.25	725.75
	S29	343.25	349.75		53	727.25	733.75
	S30	351.25	357.75		54	735.25	741.75
	S31	359.25	365.75		55	743.25	749.75
	S32	367.25	373.75		56	751.25	757.75
	S33	375.25	381.75		57	759.25	765.75
	S34	383.25	389.75		58	767.25	773.75
	S35	391.25	397.75		59	775.25	781.75
	S36	399.25	405.75		60	783.25	789.75
	S37	407.25	413.75		61	791.25	797.75
	S38	415.25	421.75		62	799.25	805.75
	S63	423.25	429.75		63	807.25	813.75
	S64	431.25	437.75		64	815.25	821.75
	S65	439.25	445.75		65	823.25	829.75
	S66	447.25	453.75		66	831.25	837.75
	S67	455.25	461.75		67	839.25	845.75
	S68	463.25	469.75		68	847.25	853.75
					69	855.25	861.75
			70	863.25	869.75		

\*) for technical reasons it is not possible to make these sound carriers audible.

**17.7 I standard**

Range	Channel	Video Carrier in MHz	Sound Carrier in MHz	Range	Channel	Video Carrier in MHz	Sound Carrier in MHz	
<b>I</b>	IA=1	45.75	51.75	<b>IV</b>	21	471.25	477.25	
	IB=2	53.75	59.75		22	479.25	485.25	
	IC=3	61.75	67.75		23	487.25	493.25	
<b>USB</b>	S2	112.25	118.25		24	495.25	501.25	
	S3	119.25	125.25		25	503.25	509.25	
	S4	126.25	132.25		26	511.25	517.25	
	S5	133.25	139.25		27	519.25	525.25	
	S6	140.25	146.25		28	527.25	533.25	
	S7	147.25	153.25		29	535.25	541.25	
	S8	154.25	160.25		30	543.25	549.25	
	S9	161.25	167.25		31	551.25	557.25	
	<b>III</b>	ID =4	175.25		181.25	32	559.25	565.25
IE =5		183.25	189.25		33	567.25	573.25	
IF =6		191.25	197.25		34	575.25	581.25	
IG =7		199.25	205.25		35	583.25	589.25	
IH 8		207.25	213.25		36	591.25	597.25	
IJ =9		215.25	221.25		37	599.25	605.25	
IK =10		223.25	229.25	<b>V</b>	38	607.25	613.25	
IL =11		231.25	237.25		39	615.25	621.25	
IM =12		239.25	245.25		40	623.25	629.25	
IN =13		247.25	253.25		41	631.25	637.25	
<b>OSB</b>		S15	259.25		265.25	42	639.25	645.25
		S16	266.25		272.25	43	647.25	653.25
		S17	273.25		279.25	44	655.25	661.25
	S18	280.25	286.25		45	663.25	669.25	
	S19	287.25	293.25		46	671.25	677.25	
	S20	294.25	300.25		47	679.25	685.25	
<b>ESB</b>	S21	303.25	309.25		48	687.25	693.25	
	S22	311.25	317.25		49	695.25	701.25	
	S23	319.25	325.25		50	703.25	709.25	
	S24	327.25	333.25		51	711.25	717.25	
	S25	335.25	341.25		52	719.25	725.25	
	S26	343.25	349.25		53	727.25	733.25	
	S27	351.25	357.25		54	735.25	741.25	
	S28	359.25	365.25	55	743.25	749.25		
	S29	367.25	373.25	56	751.25	757.25		
	S30	375.25	381.25	57	759.25	765.25		
	S31	383.25	389.25	58	767.25	773.25		
	S32	391.25	397.25	59	775.25	781.25		
	S33	399.25	405.25	60	783.25	789.25		
	S34	407.25	413.25	61	791.25	797.25		
	S35	415.25	421.25	62	799.25	805.25		
	S36	423.25	429.25	63	807.25	813.25		
	S37	431.25	437.25	64	815.25	821.25		
	S38	439.25	445.25	65	823.25	829.25		
	S63	447.25	453.25	66	831.25	837.25		
	S64	455.25	461.25	67	839.25	845.25		
	S65	463.25	469.25	68	847.25	853.25		
					69	855.25	861.25	

## Chapter 18

### DiSEqC Command Table

The switching commands for DiSEqC are transmitted serially as encrypted digital words. As is customary in computer technology, eight bits form one byte (decreasing order), followed by a parity bit (uneven). The DiSEqC data word consists of a start byte, an address byte and a command byte to which an additional data byte can follow.

<b>Start byte</b>	<b>P</b>	<b>Address</b>	<b>P</b>	<b>Command</b>	<b>P</b>	(Data)	P
-------------------	----------	----------------	----------	----------------	----------	--------	---

The response from the Slave, if demanded, is composed of the start byte for protocol and possibly attached data.

<b>Start byte</b>	<b>P</b>	(Data)	P
-------------------	----------	--------	---

#### 18.1 Start byte

The start byte contains a bit sequence for synchronizing the reception of the direction identifier and protocol data.

Start byte	Binary data	Definition
E0	1110 0000	Command from Master, confirmation released, first transmission
E1	1110 0001	Command from Master, confirmation released, repeat
E2	1110 0010	Command from Master, confirmation awaited, first transmission
E3	1110 0011	Command from Master, confirmation awaited, repeat
E4	1110 0100	Answer from Slave, OK, no error
E5	1110 0101	Answer from Slave, command not executable
E6	1110 0110	Answer from Slave, parity error – repeat demanded
E7	1110 0111	Answer from Slave, command not recognized – repeat necessary

#### 18.2 Address byte

The DiSEqC components are addressed differently according to their functions. Related components are combined in address groups (families). The first four bits of the address indicate the family, the last four indicate the variations within the family.

Address	Binary data	Family or Type
00	0000 0000	All families (universal address)
10	0001 0000	All switching components
11	0001 0001	LNB
12	0001 0010	LNB with loop-in
14	0001 0100	Switch (multi-switch, relay)
15	0001 0101	Switch with loop-in
18	0001 1000	SMATV
20	0010 0000	All polarisers
30	0011 0000	All antenna positioners
40	0100 0000	All installation aids
41	0100 0001	Signal strength indicator
6x	0110 xxxx	Deviation range for address conflicts
70	0111 0000	Interface for Multi-Master-Adapter
Fx	1111 xxxx	Extensions

### 18.3 Command byte

The actual control commands are transmitted in the control byte. The following is a small excerpt from the commands list.

Hex byte	Command	Function
00	<b>Reset</b>	Restarts the Slave micro-controller
02	Standby	Switches periphery power off
03	Power on	Switches periphery power on
07	Address	Readout of Slave address
10	Status	Readout of Slave register
11	Config	Readout of configuration register
14	Switch 0	Readout of current switching status
20	Set Lo	Selection of low band
21	Set VR	Selection of vertical level (or right rotation)
22	Set Pos A	Selection of satellite system A
23	Set S0A	Option of selection A
24	Set Hi	Selection of high band
25	Set HL	Selection of horizontal level (or left rotation)
26	Set Pos B	Selection of satellite system B
27	Set S0B	Option of selection B
38	Write N0	Direct writing of IF path
51	LO now	Readout of current local oscillation frequency
52	LO Lo	Readout of low local oscillation frequency
53	LO Hi	Readout of high local oscillation frequency

### 18.4 Optional data byte

Several DiSEqC commands require the transfer of additional data, which are then transmitted in the data byte. The data byte of command 38, for example, contains the complete "route directions" of the IF path.

### 18.5 Configuration data

Since the DiSEqC is configured for bidirectional communication, a DiSEqC master can query a slave for its capabilities and therefore determine the availability of certain functions. Switching state bytes and status/configuration data are available for this.

#### 18.5.1 Switching state byte

The answer to command 14 is the switching state byte. Here you can see what the component can switch, what states are predefined and what setting is currently selected.

Bit number	Switch position
.7	Options switch set to <b>B</b>
.6	Satellite position <b>B</b> is selected
.5	Horizontal polarisation is selected
.4	High band is selected
.3	Options switch is available
.2	Satellite position can be selected
.1	Polarisation can be selected
.0	Frequency band can be selected

### 18.5.2 Status byte

As a response to command 10, the Slave sends the contents of its status register back. The register contains information about bus collisions, completed reset commands, power supply and standby mode.

Bit number	Status
.7	Bus collision bit is set
.6	Standby mode is selected
.5	<b>free</b>
.4	External power supply available
.3	free
.2	Remote supply voltage is greater than 15V
.1	free
.0	Reset flag

### 18.5.3 Configuration byte

The configuration byte, which can be accessed with command 11, contains the exact descriptions of components.

Bit number	Component can...
.7	... output an analog control signal
.6	... be set to standby mode
.5	... <b>control a rotatable antenna</b>
.4	... be supplied with external power
.3	... loop in IF signals
.2	<b>free</b>
.1	... switch signals
.0	... report oscillator frequencies

---

**Note for internet users:** The complete DiSEqC specifications can be downloaded at <http://www.eutelsat.com>.

---

**Index**

---

<b>1</b>	
12V power supply-----	15
<b>A</b>	
Accessing memory-----	73
Accessing the constellation diagram-----	59
Activating/deactivating the hum measurement during printing-----	86
Additional settings for DiSEqC 1.2-----	32
Additional settings for DiSEqC 2.0-----	32
Address byte-----	117
ADR decoder-----	107
Analog level measurement and video check-----	21
Analysator starten im SAT-Bereich, wenn UNICABLE aktiviert ist-----	76
Analyzer-----	74
Assessing the picture and sound-----	45, 48, 52, 56
Automatic paper feed-----	101
Automatic printout-----	81
Automatic storage-----	82
<b>B</b>	
B/G standard-----	110
B/G standard (Australien)-----	111
Battery charge display-----	90
Battery operation-----	16
Blanking interval-----	40
<b>C</b>	
Cable range-----	77
Calibration-----	6
Changing the language-----	81
Changing the Lithium-Ion battery-----	18
Changing the NiMH battery-----	16
Changing the standard-----	81
Changing the symbol rate-----	45, 47, 51
Charging the NiMH battery-----	16
CI (Common Interface)-----	70
Cleaning-----	6
Cleaning the heating bar-----	102
Command byte-----	118
Configuration byte-----	119
Configuration data-----	118
Constellation diagram-----	58
Constellation diagram (COFDM)-----	58
Constellation diagram (QAM)-----	54
Constellation diagram (QPSK)-----	47
Constellation diagram (QPSK,8PSK)-----	50
<b>D</b>	
D/K standard (OIRT)-----	112
Deactivating/activating power-saving mode-----	85
Deactivation of the high pass filter for channel S2/S3-----	85
Default setting-----	92
Definition of Level-----	109



Discharge warning (lead battery) -----	19
Discharge warning (NiMH battery) -----	17
DiSEqC Command Table -----	117
DiSEqC control (version 1.0, version 1.2 and version 2.0) -----	30
Displaying data and time -----	84
Displaying software version -----	91
Displaying the MPEG video parameters -----	68
DOCSIS -----	54
DVB and MPEG-2 -----	65
DVB-C (QAM) -----	63
DVB-C (QAM) or DOCSIS -----	50
DVB-S (QPSK) -----	44, 62
DVB-S2 (QPSK, 8PSK), DVB-S1 (QPSK) (with optional DVB-S2 card only) -----	47
DVB-T (COFDM) -----	54, 64
DVI Interface -----	68
DVI-Ausgang -----	15
<b>E</b>	
Editing protocol header -----	84
Erasing a memory location -----	73
Erasing tuning memory -----	80
Examples of constellation diagrams -----	62
External 12V power supply -----	20
<b>F</b>	
Finding a frequency with the cursor -----	78
FM broadcasting range -----	22
FM range -----	76
Freezing the diagram -----	59
Freezing the oscillogram -----	42
Frequency detuning -----	39
Frequency input (1. SAT-IF or direct RF transponder frequency) -----	25
Front panel -----	13
<b>H</b>	
HDTV and MPEG-4 -----	66
Headphone jack -----	15
Hum measurement -----	42
Hum measurement at QAM -----	60
<b>I</b>	
I standard -----	116
IF range -----	77
Impulse response -----	57
Inserting the lead battery -----	18
Introduction -----	65
<b>L</b>	
L standard -----	115
Lead battery operation -----	18, 90
Level measurement -----	45, 48, 51, 55
List of Special Programs -----	79
List of TV Channels -----	110
Lithium-Ion battery operation (Option) -----	18
LNB current measurement -----	98
LNB supply -----	29
<b>M</b>	
M/N standard -----	114
Mains operation -----	16
Maintenance -----	5
Manual paper feed -----	101
Measured value storage -----	96

Measurement and display of the video bit rate	68
Measurements in the digital range	44
Measuring phase jitter with QAM	59
Measuring the bit error rate	56
Measuring the bit error rate (BER)	52
Measuring the bit error rate (CBER or VBER)	45
Measuring the carrier frequency offset	46, 50, 52
Measuring the IQ phase position	46, 50, 53, 57
Measuring the modulation error rate (MER)	53
Measuring the package error rate (PER)	53
Measuring the signal to noise ratio (S/N) in the baseband	46, 50, 57
Memory locations	73
Monitor Function, SCART Parameters	103
Monitoring program	93
MPEG Decoder	65
MPEG transport stream interface	68
<b>N</b>	
NICAM decoder	105
NiMH battery operation	16, 90
NIT evaluation	68
<b>O</b>	
Operation (MPEG-2 and MPEG-4 decoder)	66
Optional data byte	118
Output of signal frequency (22kHz)	30
<b>P</b>	
Paper refill	100
Power-saving mode	6
Printer Functions	99
Printing out the NIT	70
Printing protocol header	85
Protect memory area	91
<b>R</b>	
Rear panel	14
Recharging the lead battery	18
Relative measurement	37
Relative measurement (with C/N display capability in SAT range)	88
Remote supply	21, 44
Replacing Components	6
Return channel range	76
Right side view	14
RS 232	15
RS-232 interface	92
<b>S</b>	
S/N measurement → line switch	89
S/N measurement, C/N measurement	38
Safety notes	5
SAT range	78
Satellite range	25
Saving	73
Scart socket (EU AV)	14
SCOPE	40
Searching, frequency detuning	45, 48, 51, 55
Selecting a line	41
Selecting the range	21, 44
Selecting the S/N line	42
Selecting the SCOPE function	41

Selection of signal bandwidths with COFDM -----87  
 Selection of sound carrier measurement (absolute oder relative) -----87  
 Sequence of memory positions -----73  
 Serial number and release code for documentation software -----89  
 Service ----- 6  
 Setting data and time -----84  
 Setting the analog bar display -----88  
 Setting the colour standard (PAL, SECAM, NTSC) -----24, 29  
 Setting the remote supply -----22  
 Single carrier representation with COFDM -----60  
 Sound carrier level measurement -----24  
 Sound carrier selection -----37  
 Special Programs -----80  
 Start byte ----- 117  
 Starting analyzer -----75  
 Startup -----16  
 Station search -----39  
 Status byte ----- 119  
 Switching state byte ----- 118  
 Switching the dB display size -----88  
 Switching the detuning input (SAT) -----86  
 Switching the detuning resolution (SAT) -----86  
 Switching the measuring resolution -----88

**T**

Technical Data ----- 7  
 Teletext -----43  
 Television IF range -----38  
 Television ranges (terrestrial and broadband cable ranges) -----23  
 Television return channel range -----38  
 Testing the bit error rate for DVB-S2 (CBER or PER) -----49  
 Testing the bit error ratio for DVB-S1 (CBER or VBER) -----49  
 TS parallel -----15  
 Tuning Memory -----73  
 Turning LCD backlighting on and off -----80  
 TV - Complete -----77  
 TV range -----77

**U**

UNICABLE System -----34  
 Usage Notes ----- 5

**V**

VHF, VHF-S, UHF -----77  
 Video deviation -----28

**Z**

Zoom function -----42, 59